

# Plage Dynamique



GIF-4105/7105 Photographie Algorithmique, Hiver 2019  
Jean-François Lalonde

Merci à P. Debevec et A. Efros!

# La plage dynamique

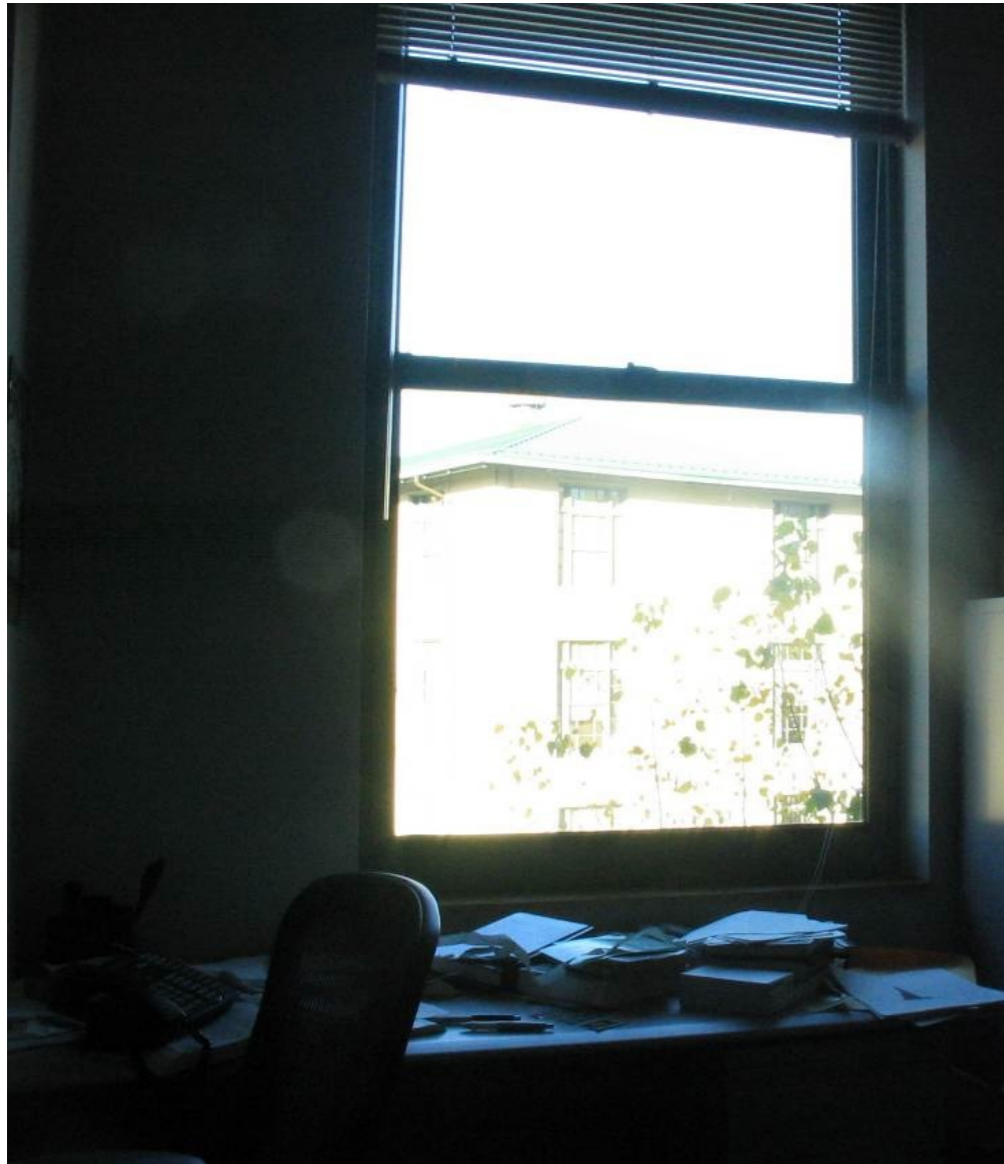

# Plage dynamique

Le monde a une haute plage dynamique!



1



1500



25,000



400,000



2,000,000,000

# Plage dynamique

Image

La caméra... pas autant

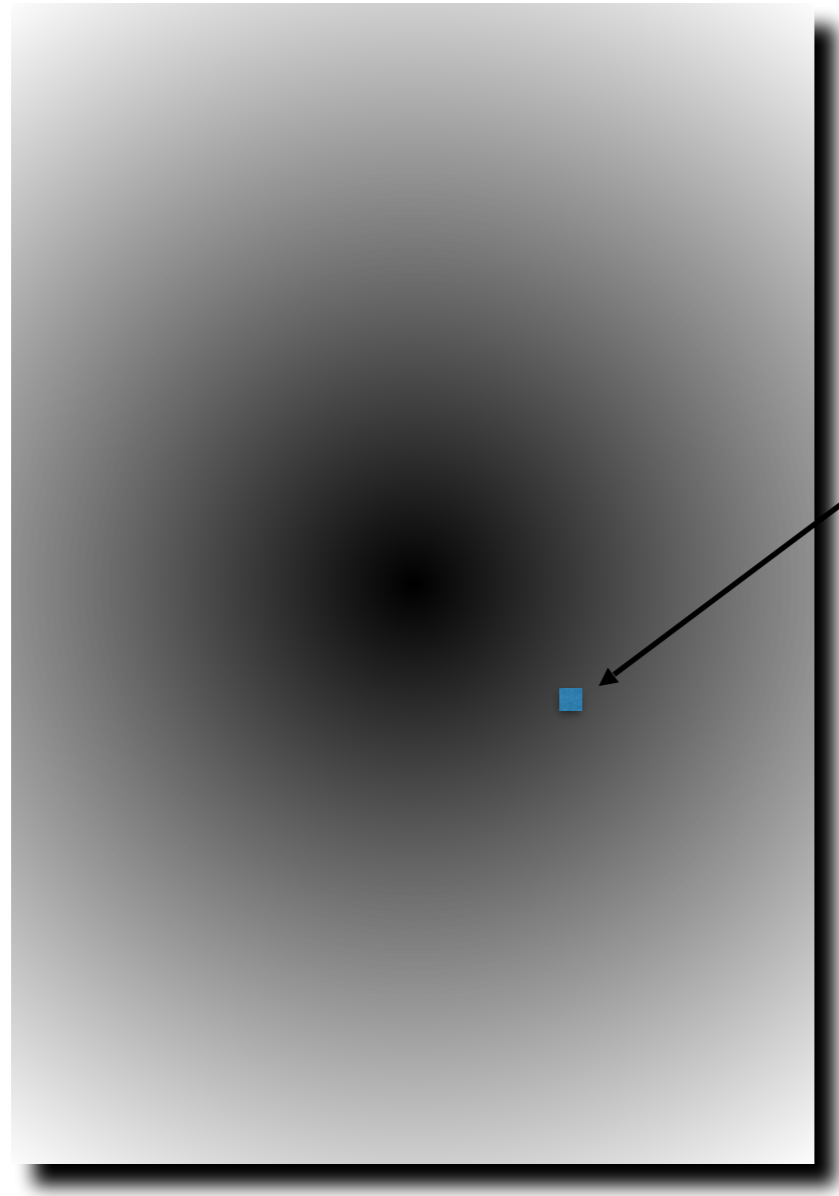

pixel (312, 284) = 42

42 quoi? photons?

# Exposition longue



$10^{-6}$

Haute plage dynamique

$10^6$

Monde



Image



0 à 255

# Exposition courte



$10^{-6}$

Haute plage dynamique

$10^6$

Monde



Image



0 à 255

# Calibrage

- Géométrie
  - Relation entre les coordonnées en pixel et les points dans le monde
- Photométrie
  - Relation entre les valeurs d'intensité des pixels et la radiance du monde

# Caméra

Image (pixels)

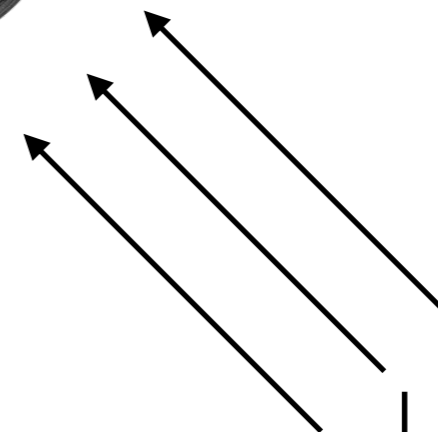

Lumière  
(radiance)



# Relation entre pixels et radiance

- Assumons une caméra « linéaire » pour le moment:

$$\text{pixel} = \text{radiance} \times \Delta t$$

- Plus l'exposition ( $\Delta t$ ) est longue, plus l'image est claire

# Estimer la radiance à partir des pixels

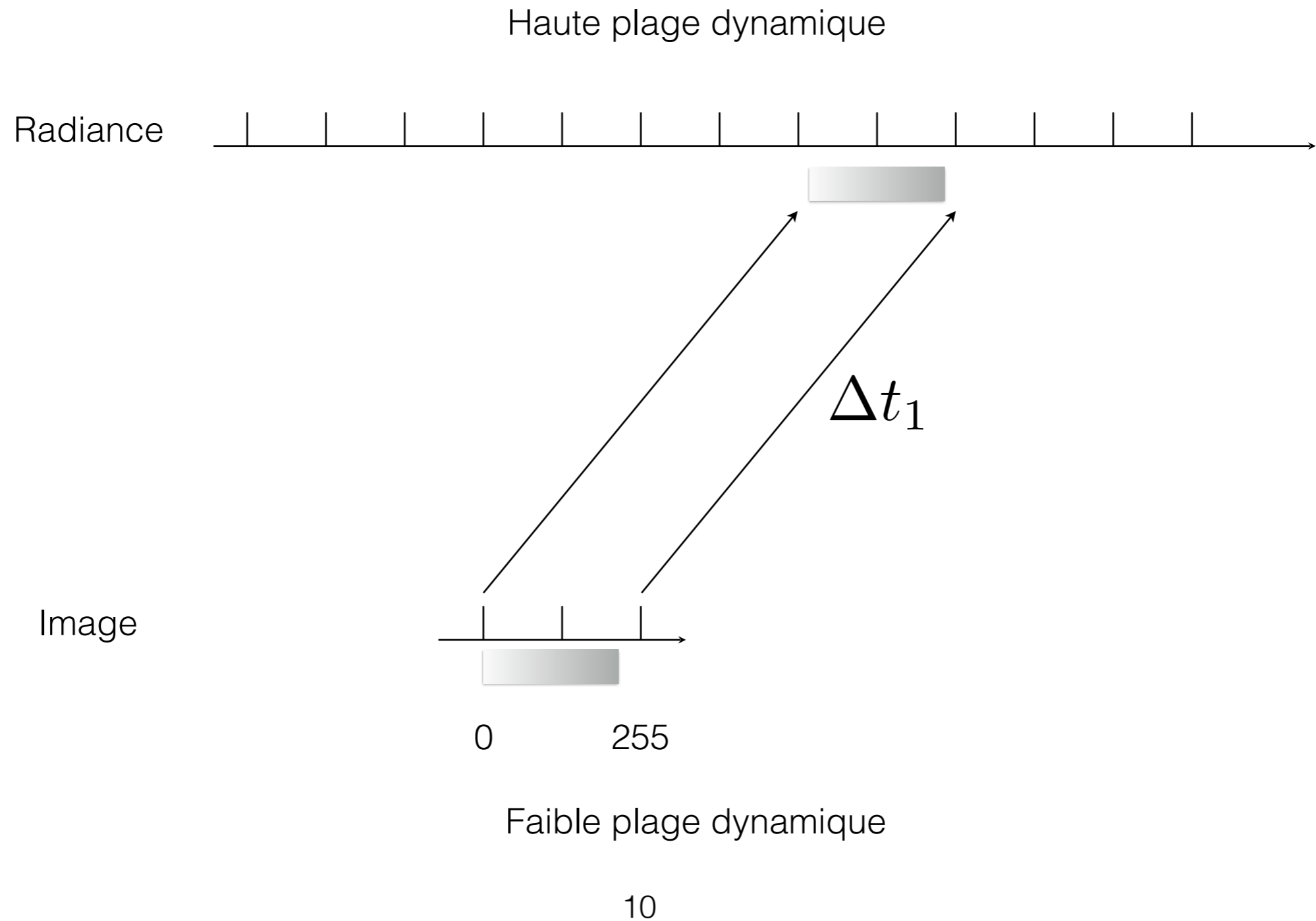

# Estimer la radiance à partir des pixels

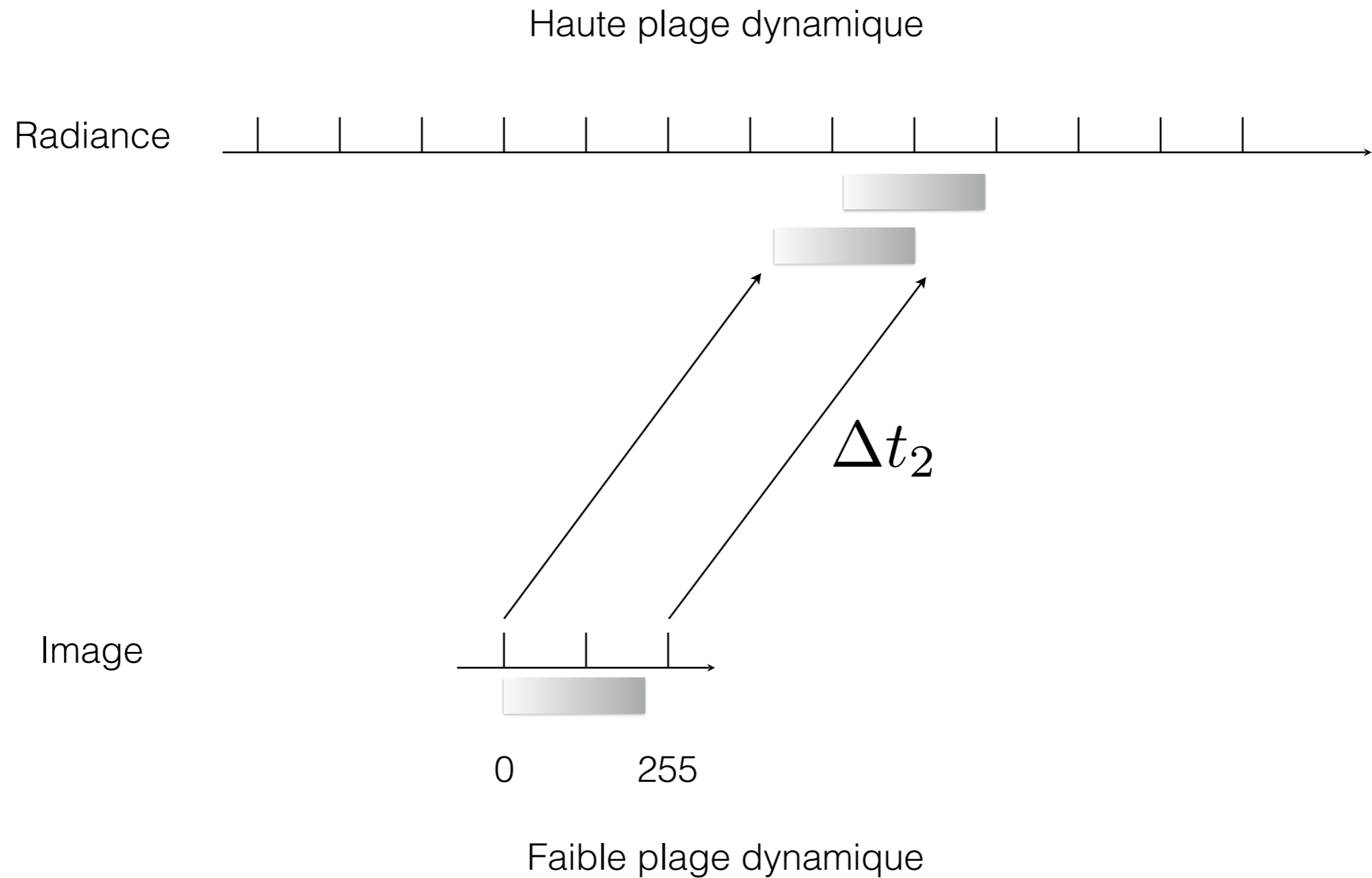

# Estimer la radiance à partir des pixels

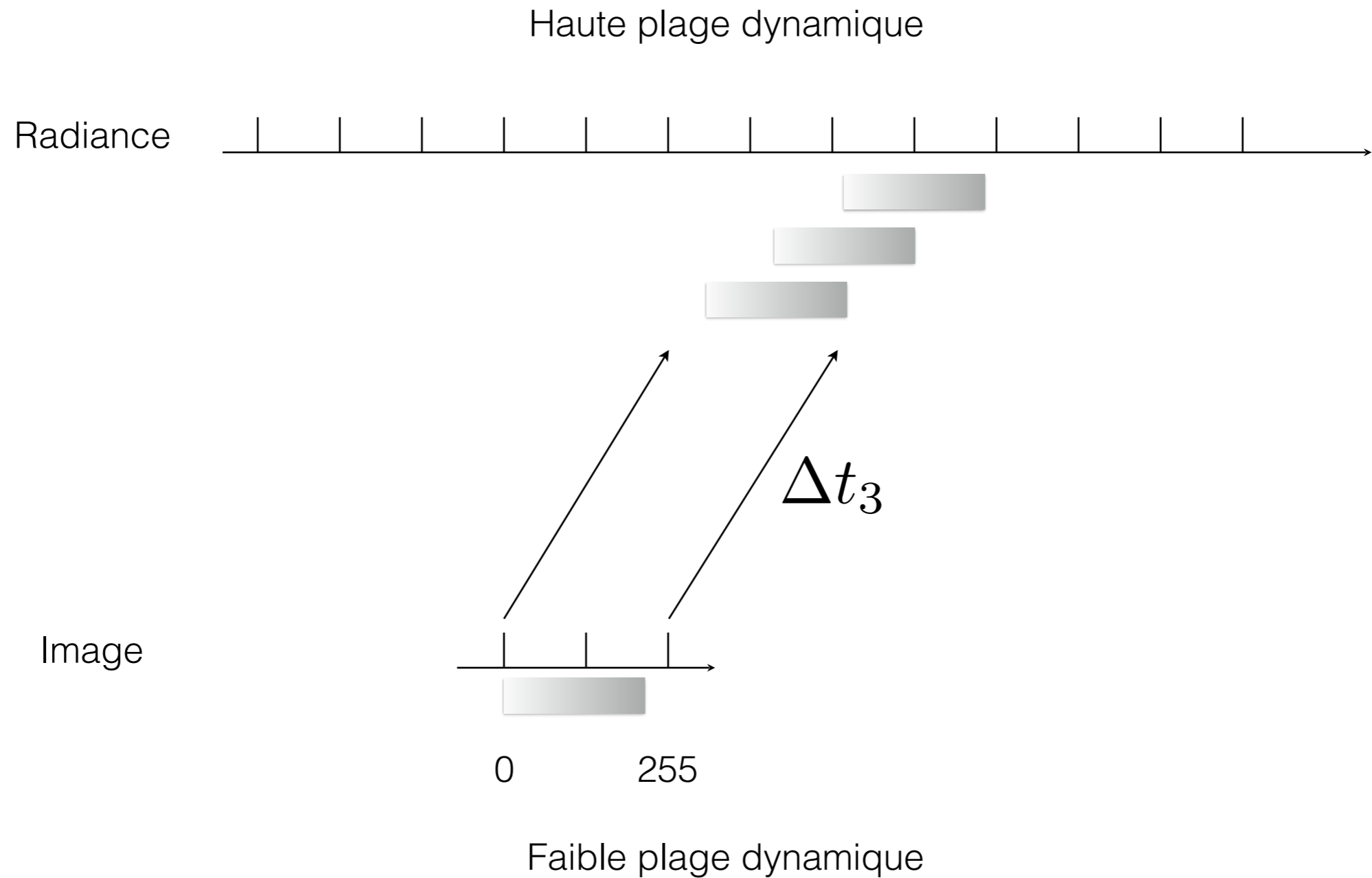

# Estimer la radiance à partir des pixels

Haute plage dynamique

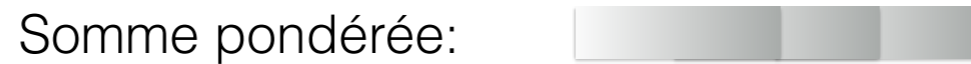
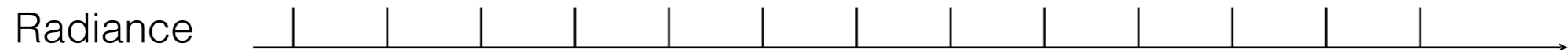

$$I_{\text{radiance}} = \sum_{i=1}^N \frac{I_i}{\Delta t_i} \quad (\text{pixel} = \text{radiance} \times \Delta t)$$

Image

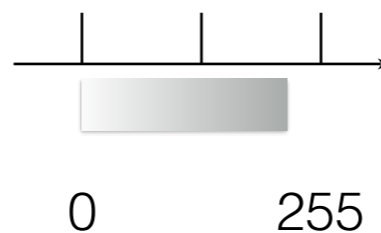

Faible plage dynamique

# Variation de l'exposition

- Temps d'obturation
  - Quel est le problème?
- F/stop (ouverture, iris)
  - Quel est le problème?
- Filtres (densité neutre)
  - Quel est le problème?



# Temps d'obturation

- Valeurs:
  - Canon D30: 30 à 1/4,000 sec.
  - Sony VX2000: 1/4 à 1/10,000 sec.
- Avantages:
  - Varie l'exposition directement
  - Facile à répéter et assez précis
- Inconvénients:
  - Longues expositions peuvent avoir du bruit

# Temps d'obturation

- Habituellement, à chaque “stop” on diminue la lumière d'un facteur 2
  - $\frac{1}{4}$ ,  $\frac{1}{8}$ ,  $\frac{1}{15}$ ,  $\frac{1}{30}$ ,  $\frac{1}{60}$ ,  $\frac{1}{125}$ ,  $\frac{1}{250}$ ,  $\frac{1}{500}$ ,  $\frac{1}{1000}$  s



# Images à plusieurs expositions



# Radiance

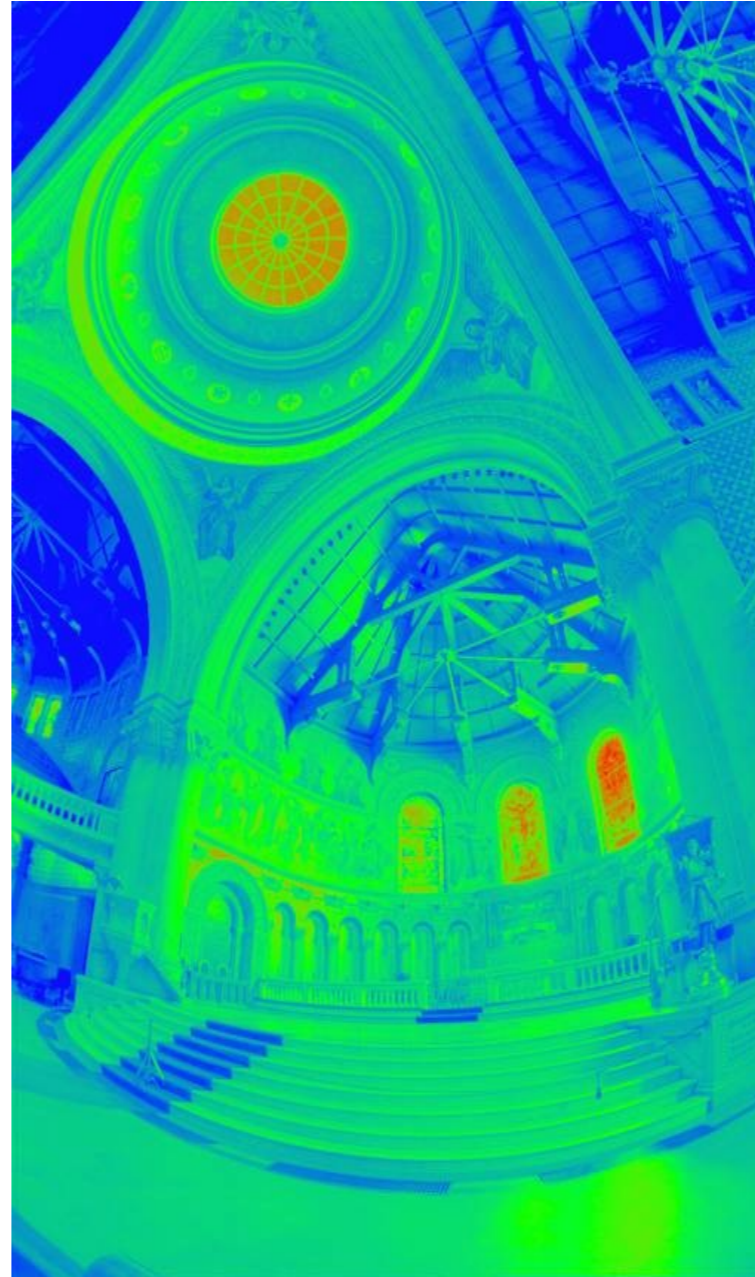

# Comment visualiser une image de radiance?



# Comment visualiser une image de radiance?

- Logiciel gratuit: LuminanceHDR

# Relation entre pixels et radiance

- Assumons une caméra « linéaire » pour le moment:

$$\text{pixel} = \text{radiance} \times \Delta t$$

- Plus l'exposition ( $\Delta t$ ) est longue, plus l'image est claire
- Cependant: est-ce qu'une caméra est vraiment linéaire?

# Ce qui se passe dans une caméra (numérique)...

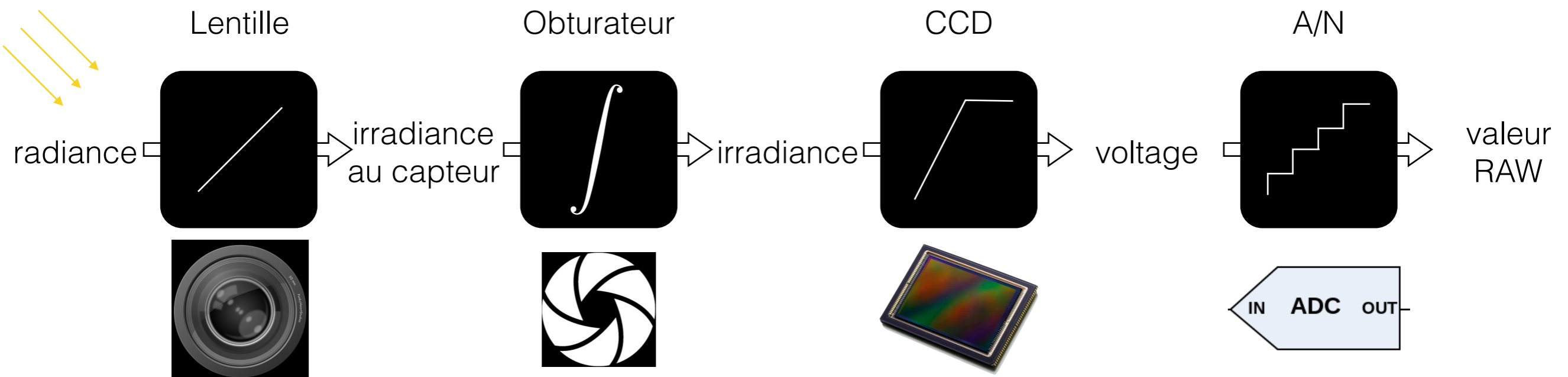

# Camera pipeline

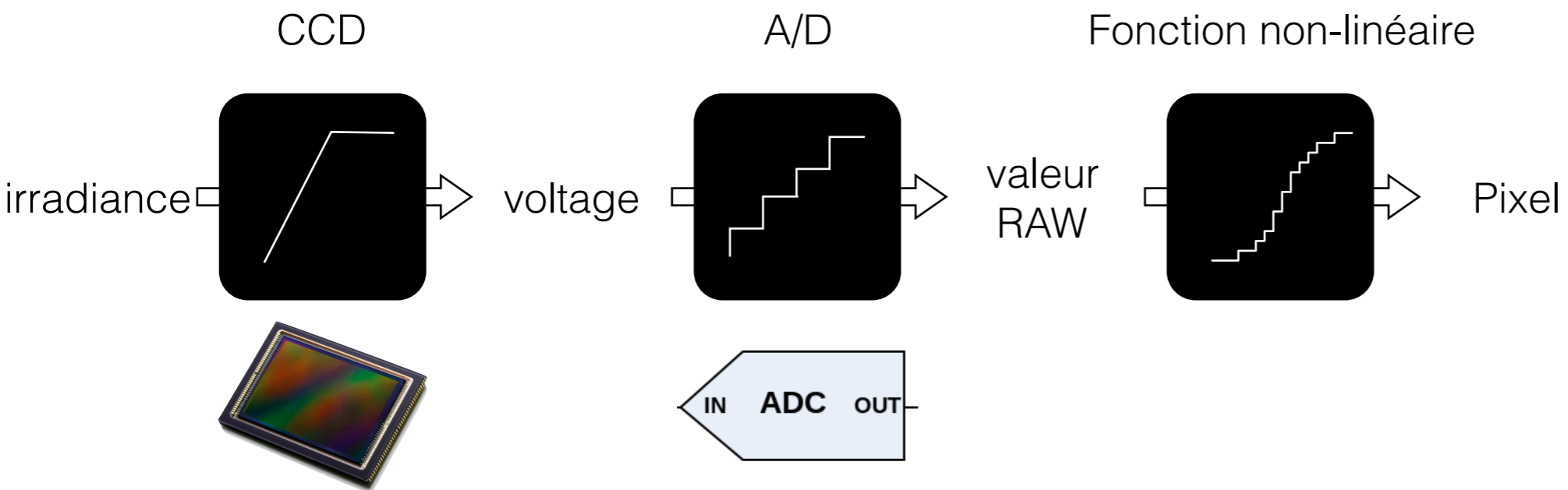

# Fonction de réponse d'une caméra

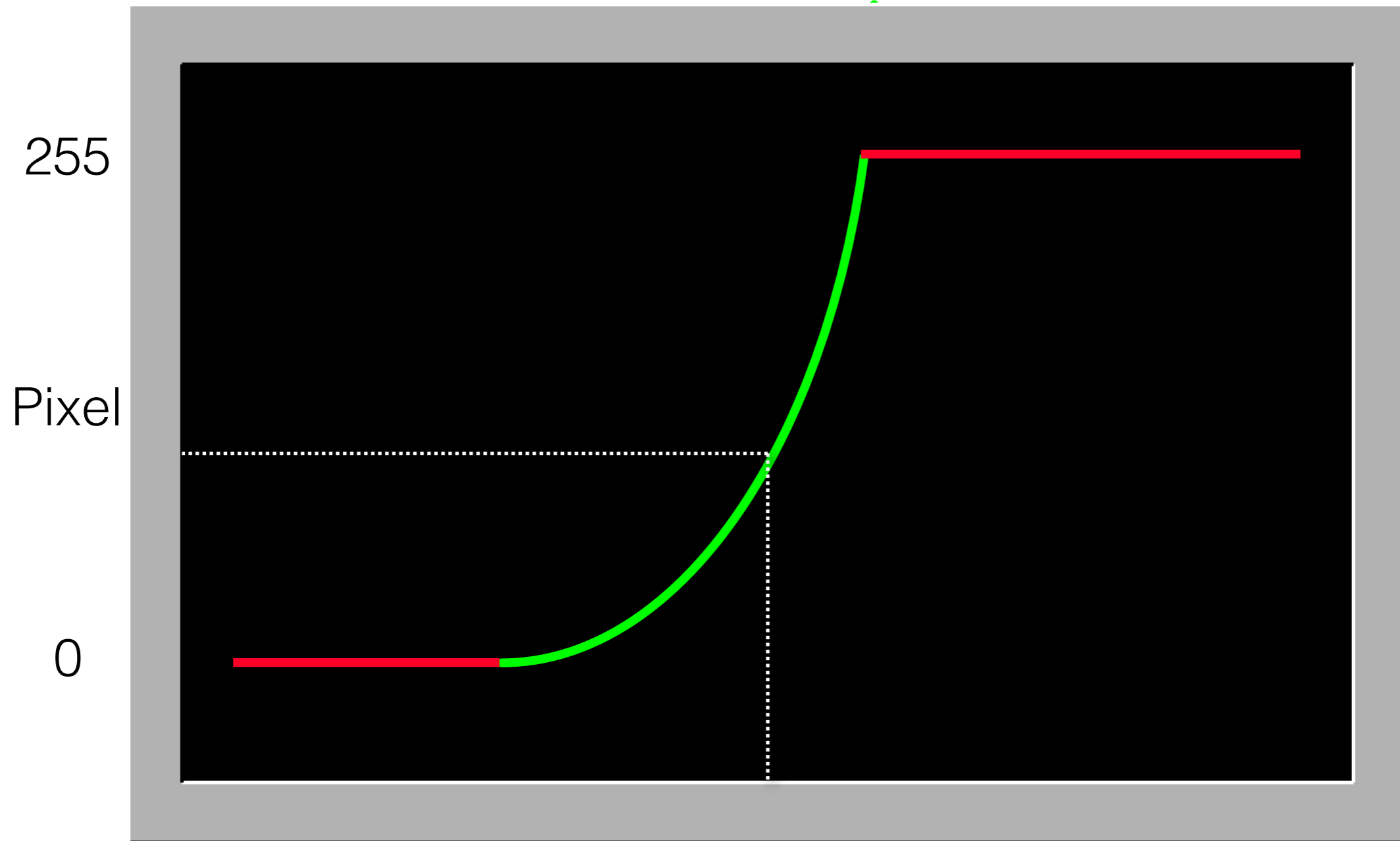

$\log \text{Exposition} = \log (\text{radiance} * \Delta t)$

(# photons au CCD)



# Systeme visuel humain

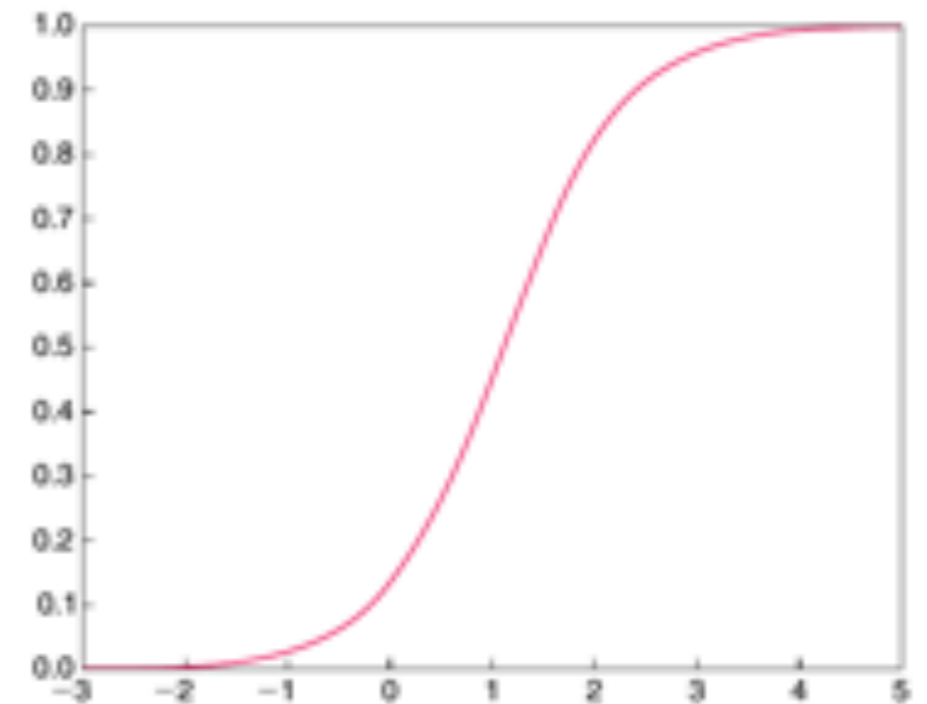
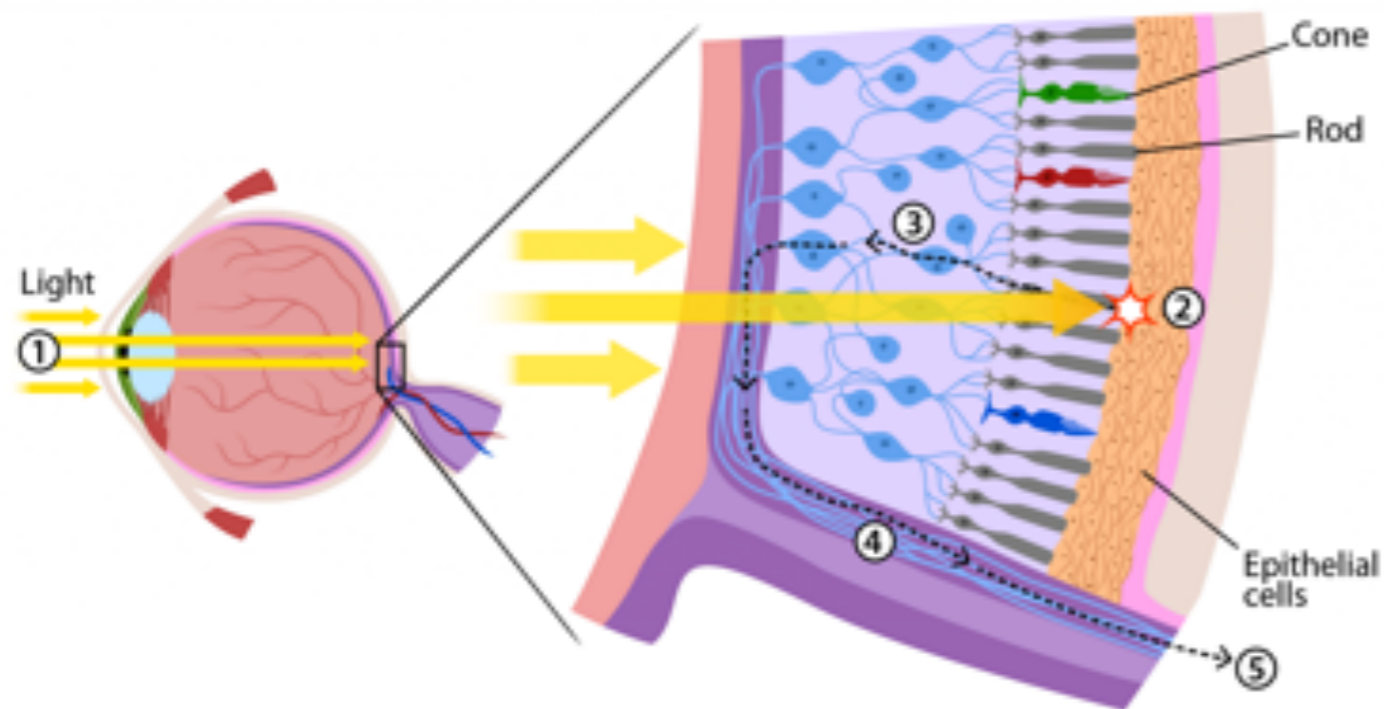

# Adaptation: nos yeux ne sont pas des photomètres!

Phares allumés,  
nuit



Phares allumés,  
jour

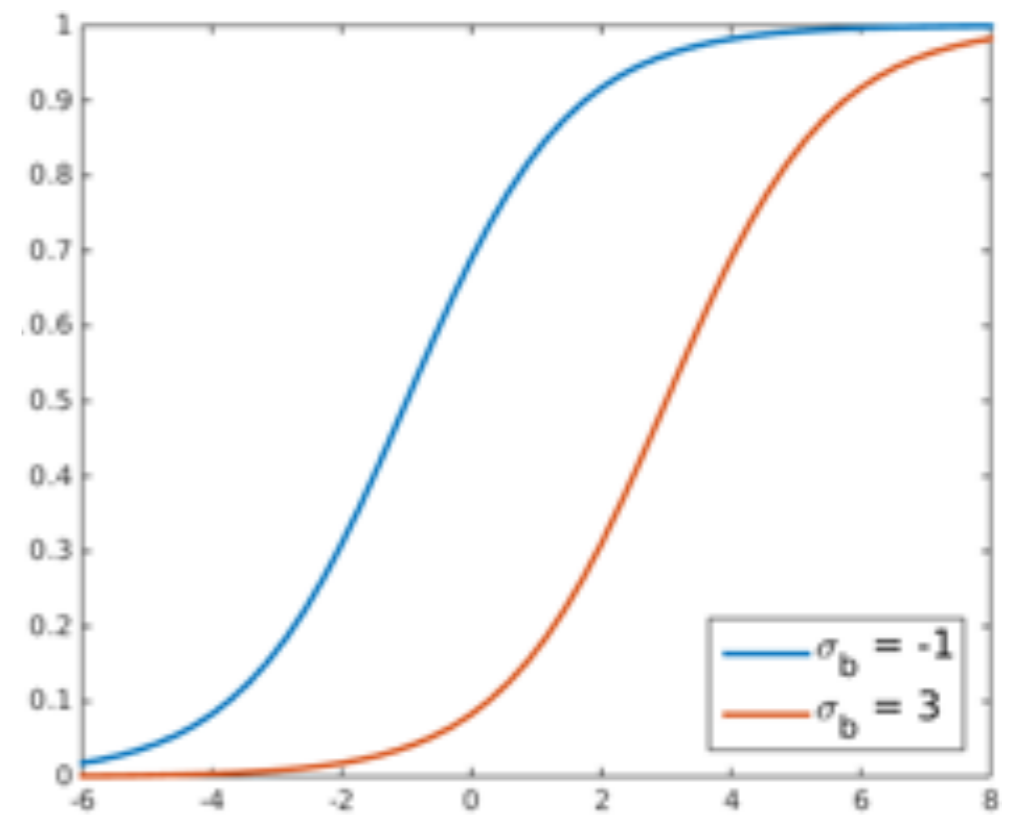

# Comment estimer la fonction de réponse d'une caméra?

- Première option
  - utiliser une cible de calibrage radiométrique

# Calibrage radiométrique

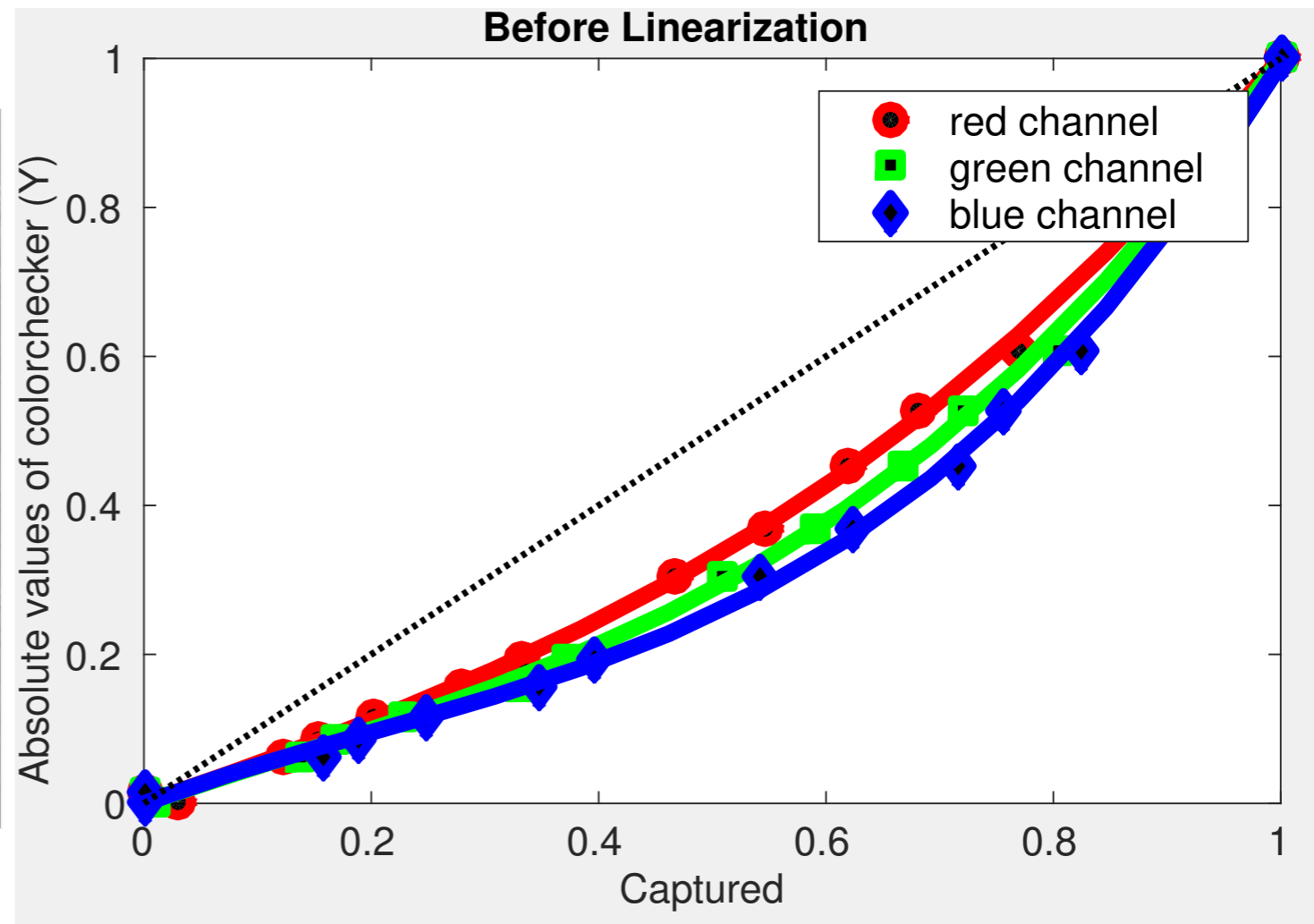

# Calibrage radiométrique

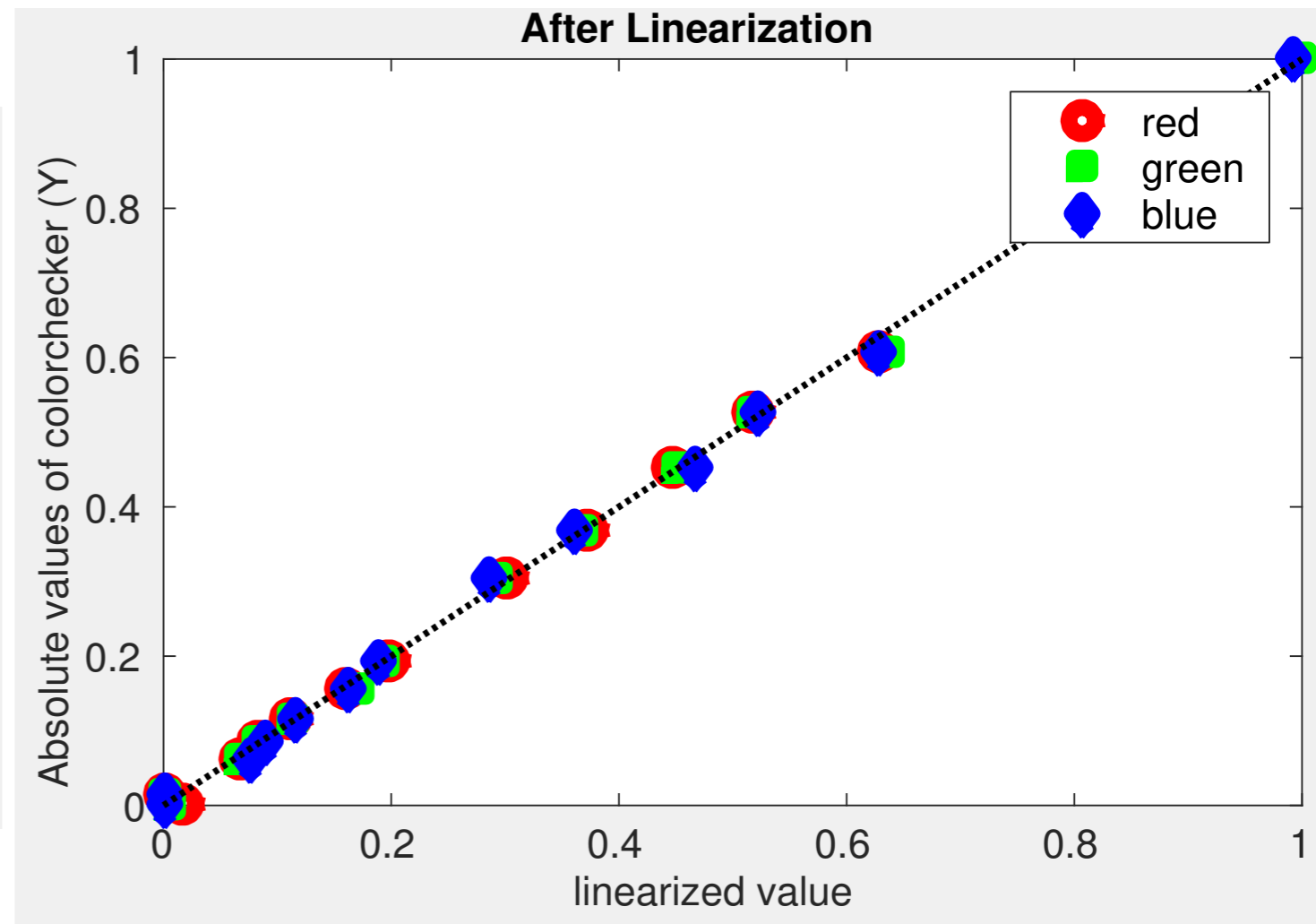
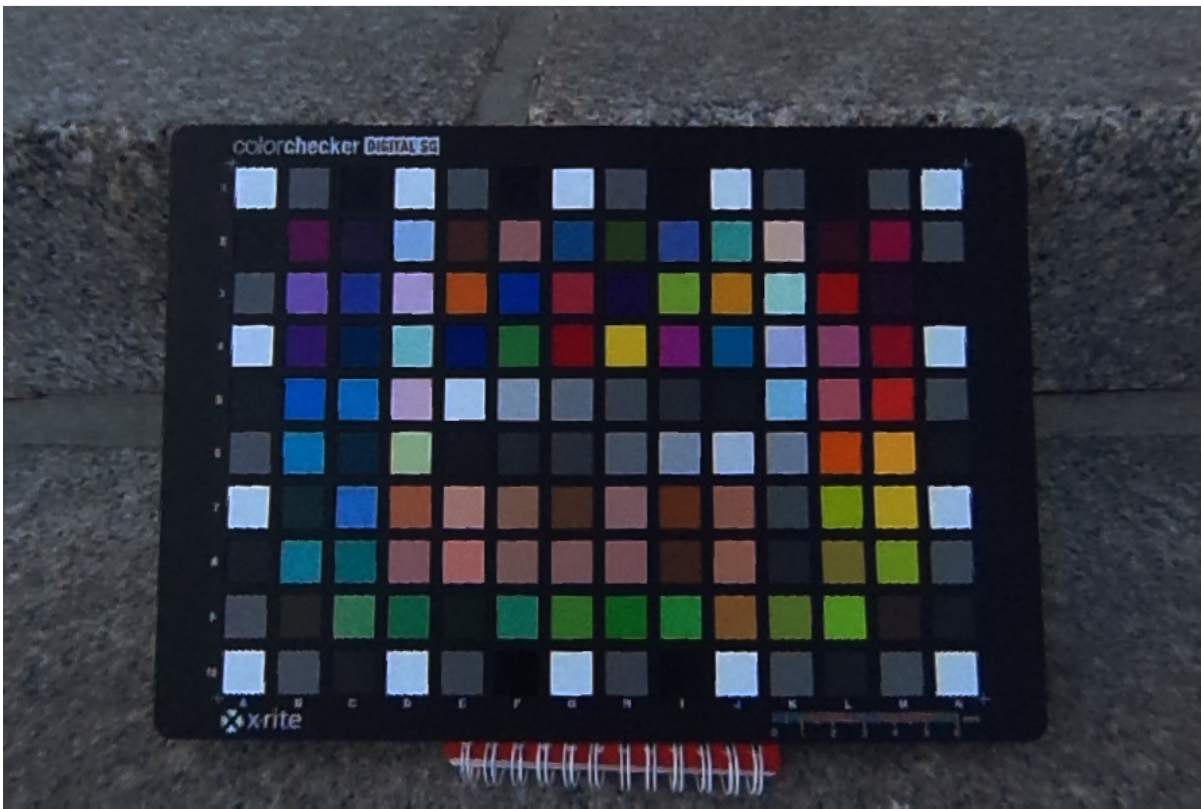

# Comment estimer la fonction de réponse d'une caméra?

- Première option
  - utiliser une cible de calibrage radiométrique
- Deuxième option
  - l'estimer automatiquement à partir des expositions!

# Algorithme

Série d'images

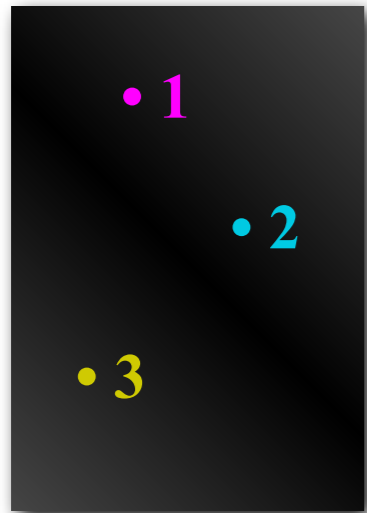

$\Delta t = 1/64 \text{ sec}$

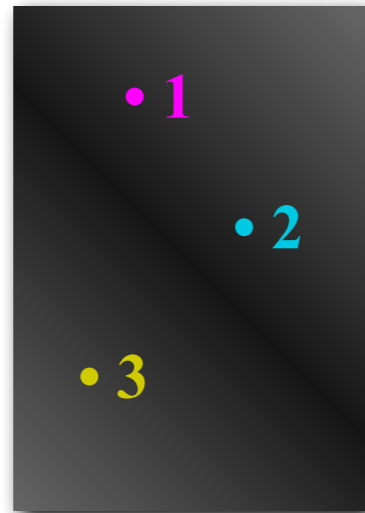

$\Delta t = 1/16 \text{ sec}$

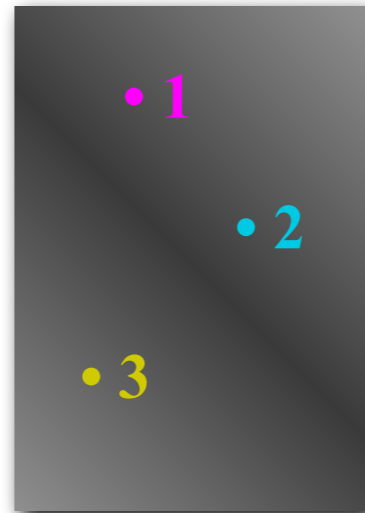

$\Delta t = 1/4 \text{ sec}$

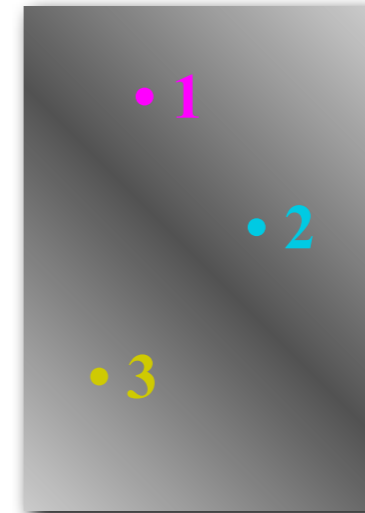

$\Delta t = 1 \text{ sec}$

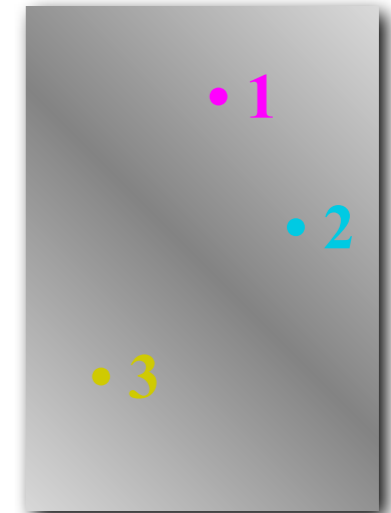

$\Delta t = 4 \text{ sec}$

$$z = f(\text{exposition})$$

$$\text{exposition} = \text{radiance} \times \Delta t$$

# Algorithme

Série d'images

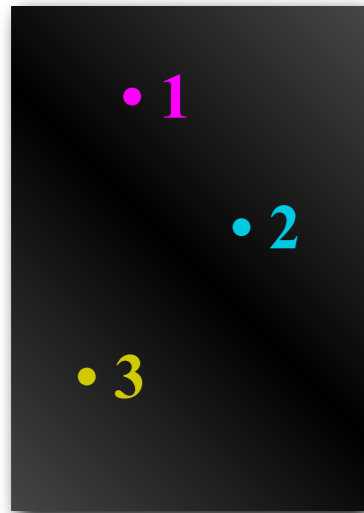

$\Delta t = 1/64$  sec

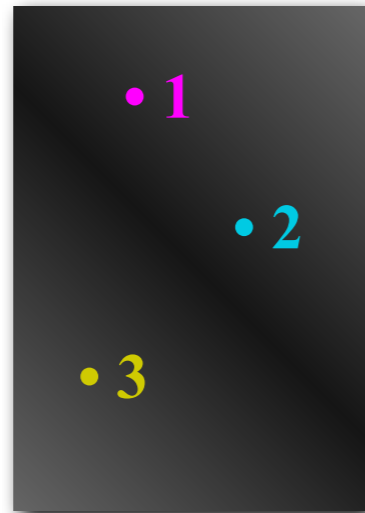

$\Delta t = 1/16$  sec

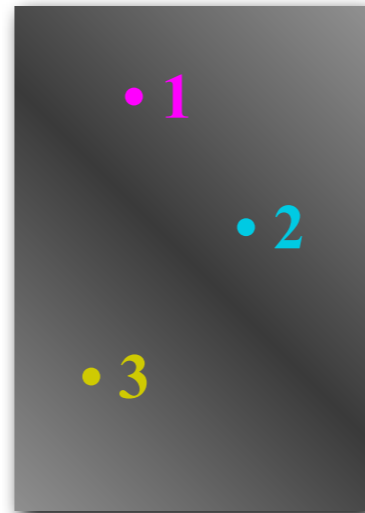

$\Delta t = 1/4$  sec

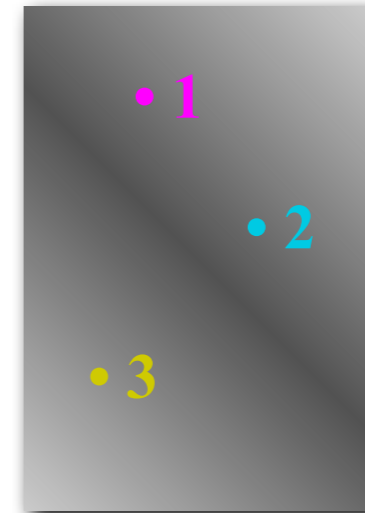

$\Delta t = 1$  sec

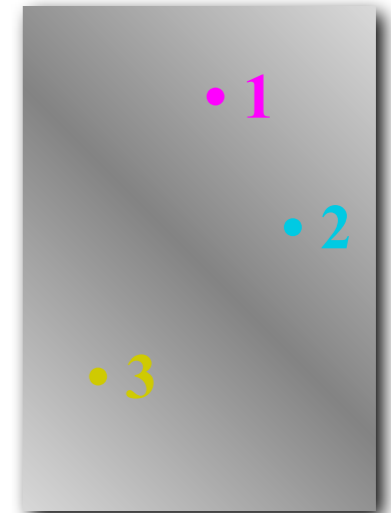

$\Delta t = 4$  sec

$$z_{ij} = f(\text{exposition}_{ij})$$

$$\text{exposition}_{ij} = \text{radiance}_i \times \Delta t_j$$

$$z_{ij} = f(\text{radiance}_i \times \Delta t_j)$$

$$\text{radiance}_i \times \Delta t_j = f^{-1}(z_{ij})$$

$$\log \text{radiance}_i + \log \Delta t_j = g(z_{ij})$$



# Math

- Notons la fonction inverse discrétisée:  $g(z)$
- Pour chaque pixel  $i$  dans une image  $j$ , nous avons:

$$\log \text{radiance}_i + \log \Delta t_j = g(z_{ij})$$

$$r_i + t_j = g(z_{ij})$$

- Système d'équations linéaires sur-contraint:

$$\sum_{i \in \text{pixels}} \sum_{j \in \text{images}} (r_i + t_j - g(z_{ij}))^2 + \lambda \sum_{z=0}^{255} g''(z)^2$$

approximation des données

courbe lisse

# Résultat

Kodak DCS460  
1/30 à 30 sec

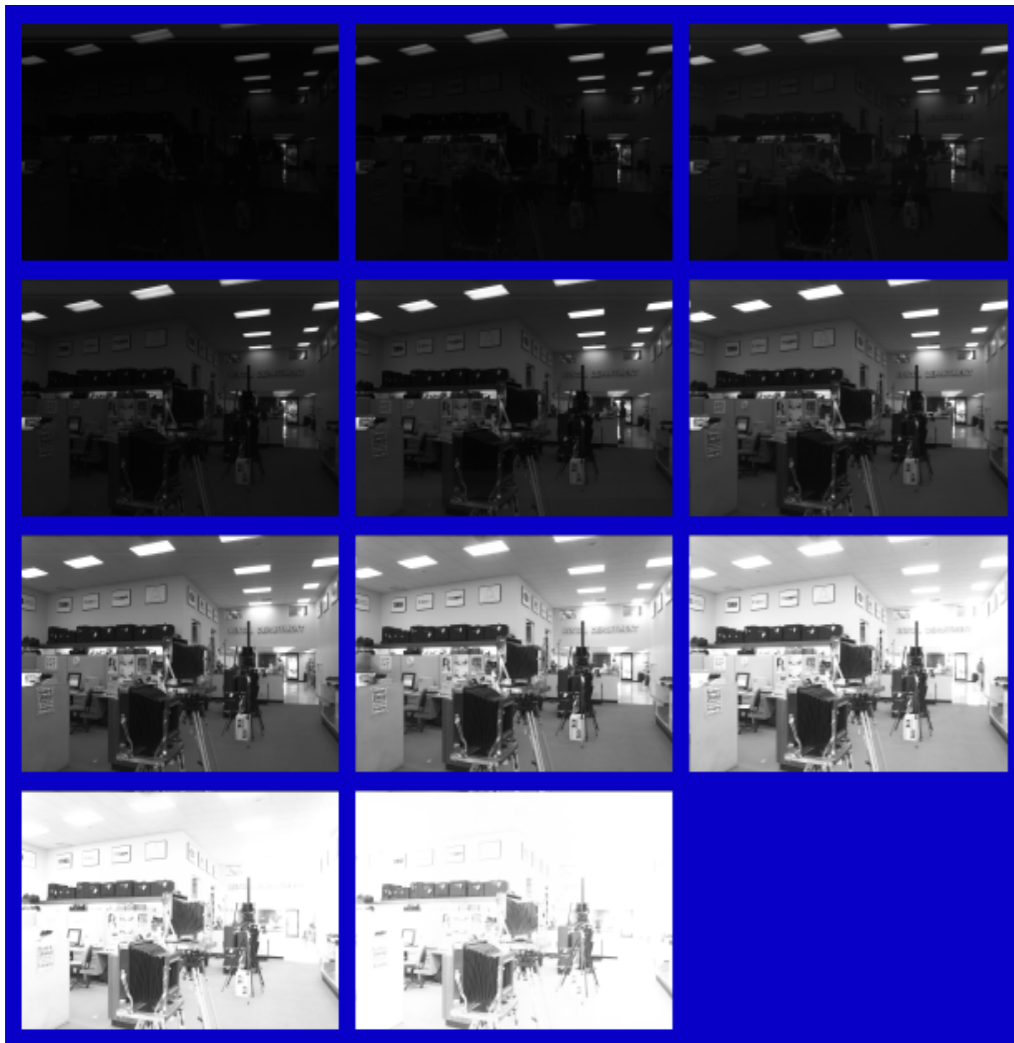

Courbe estimée

Pixel

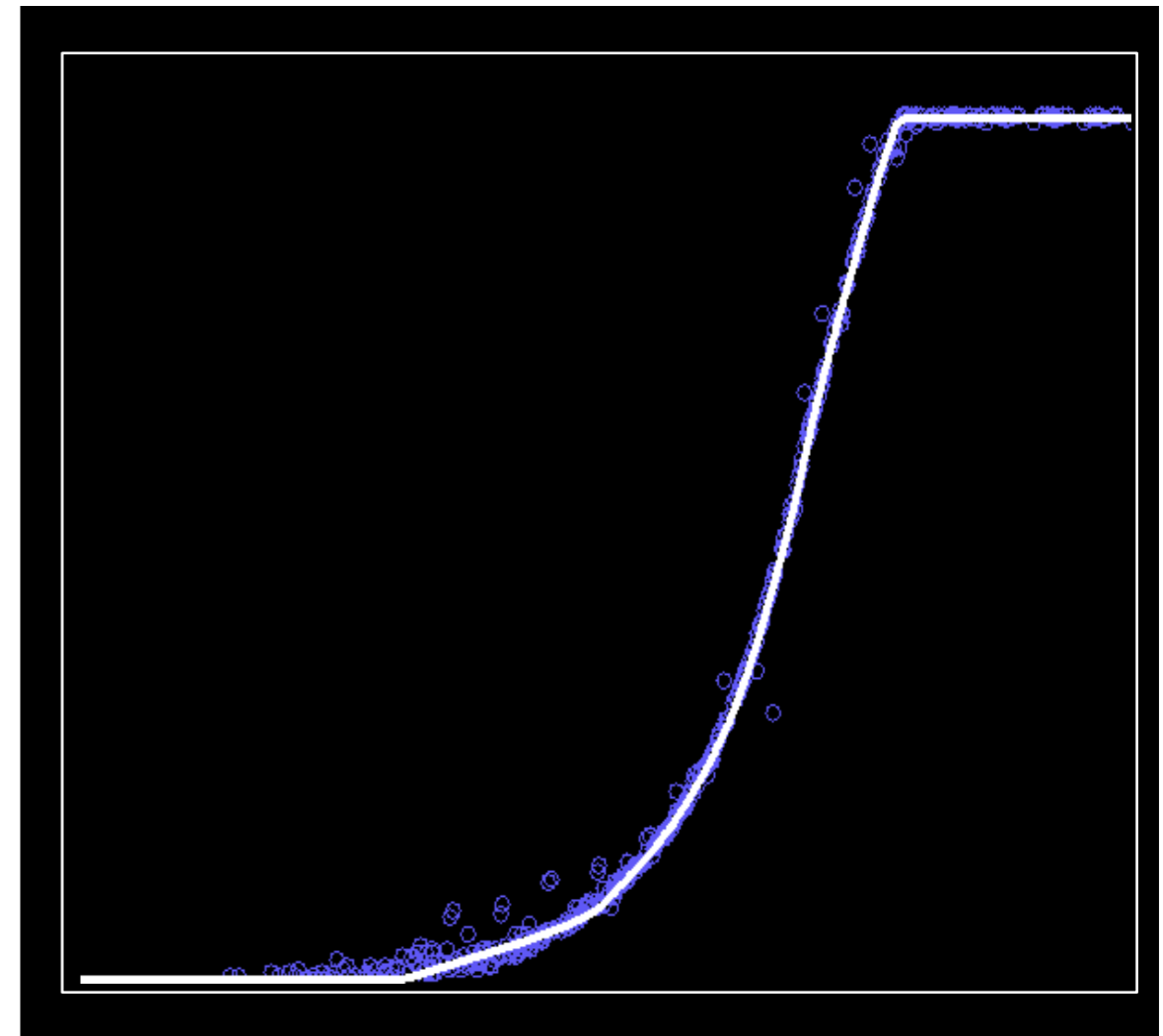

log exposition

# Radiance



# Résultats: couleur

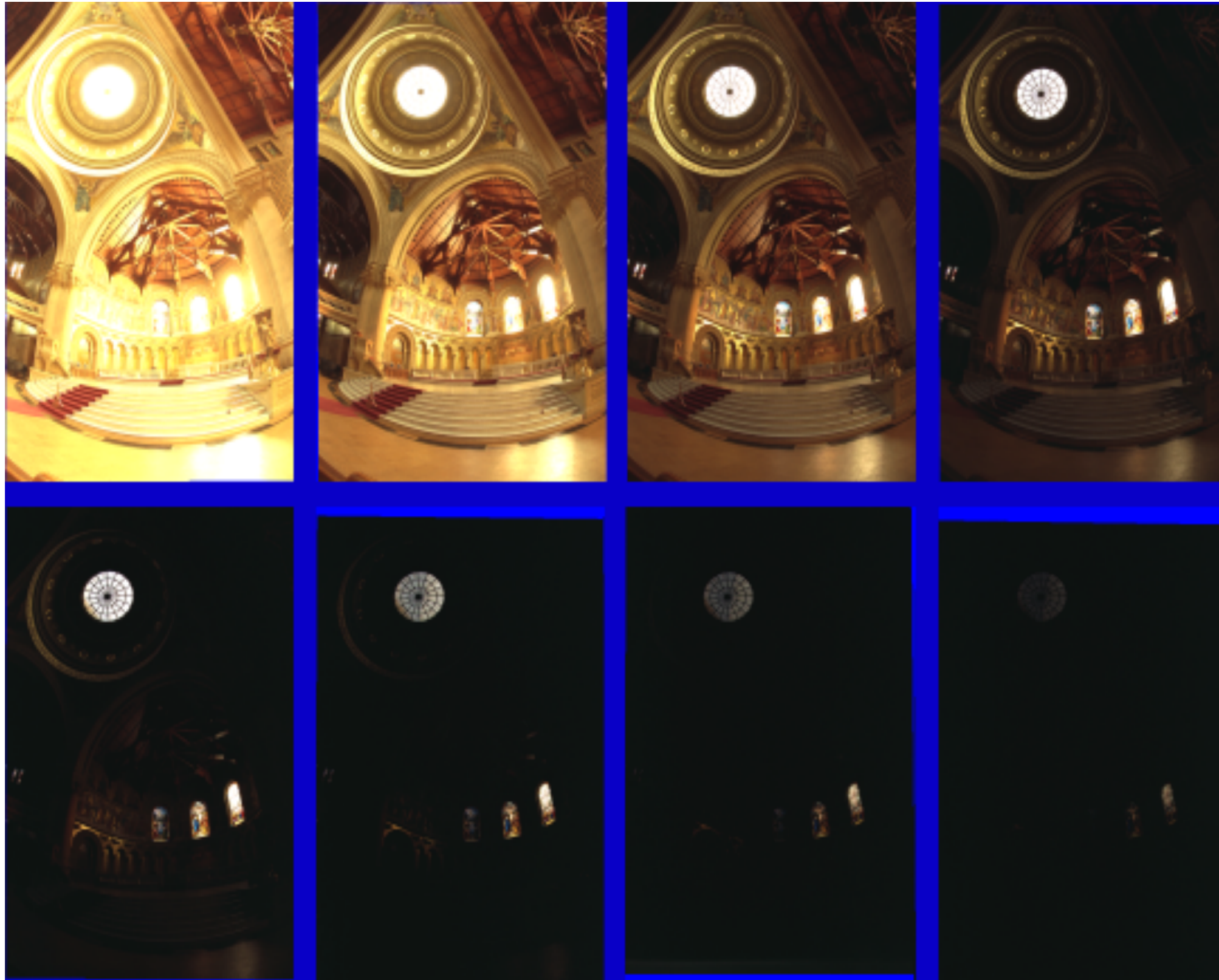

Rouge

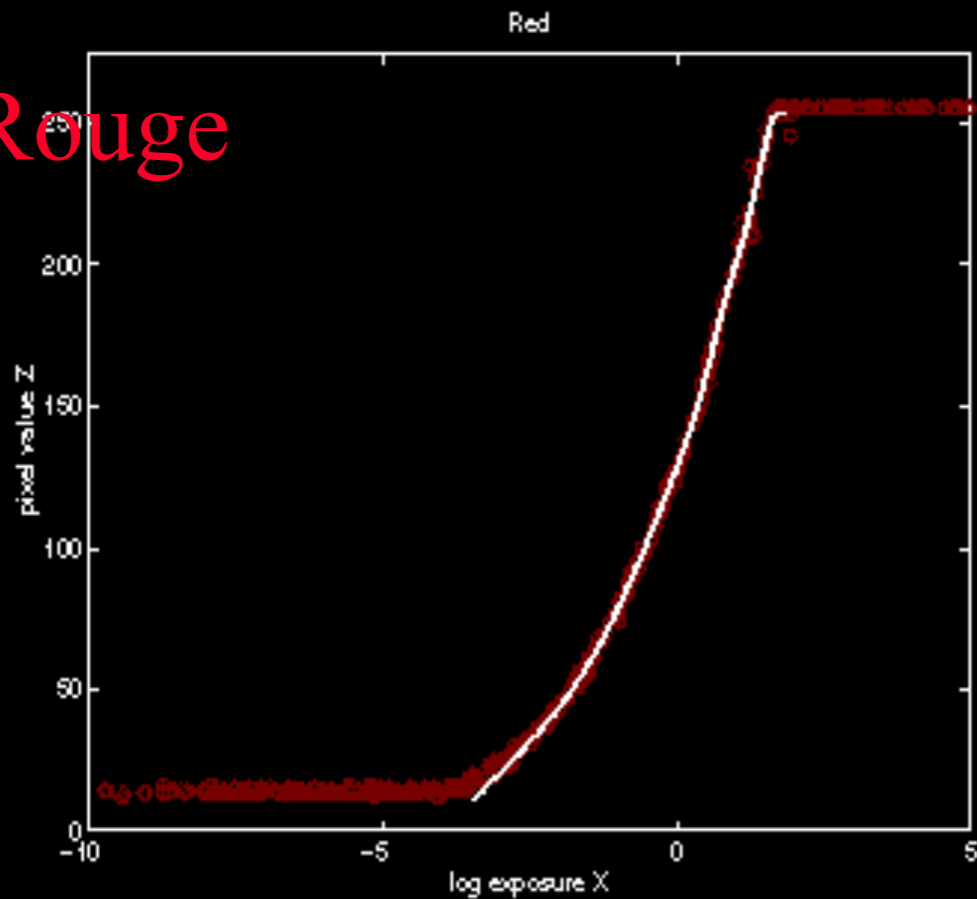

Vert

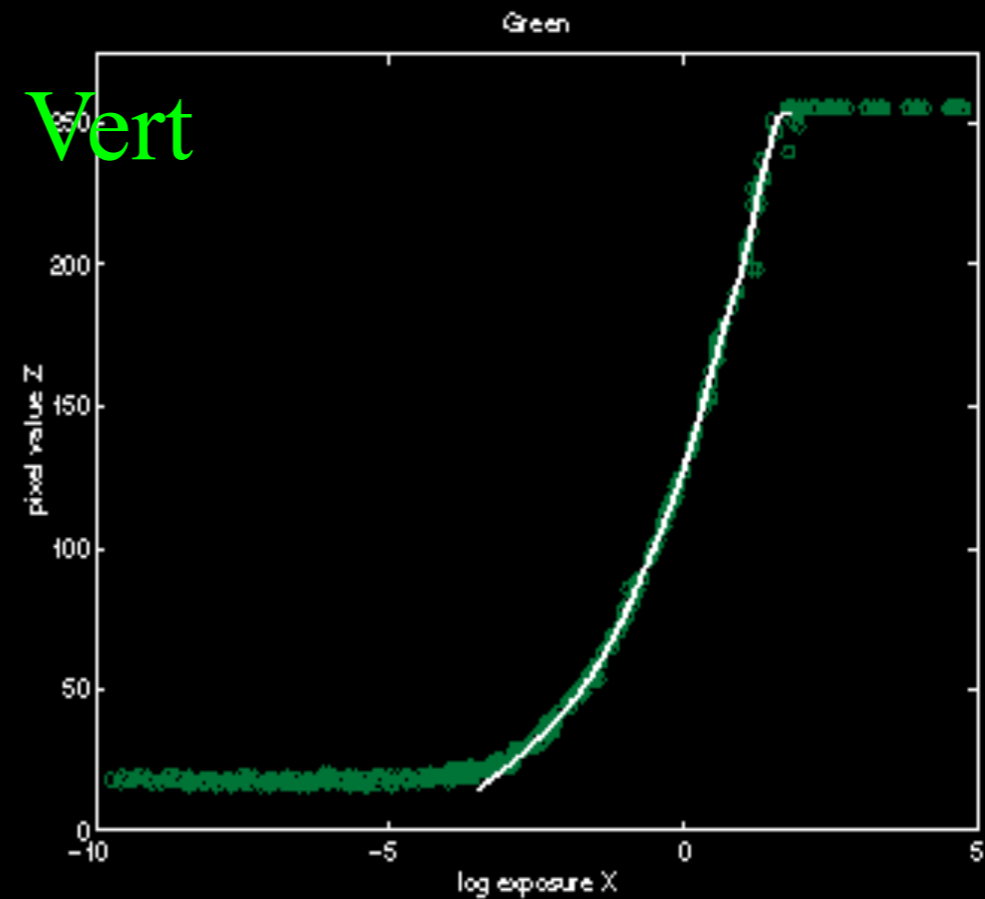

Bleu

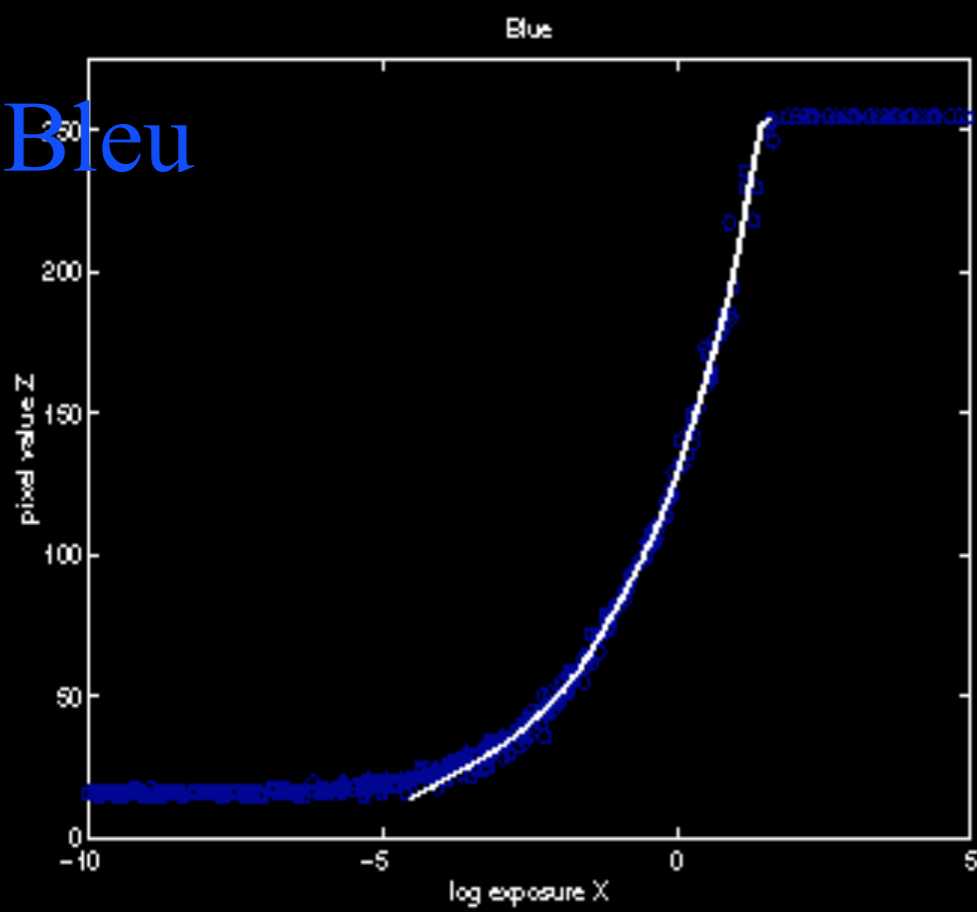

RGB

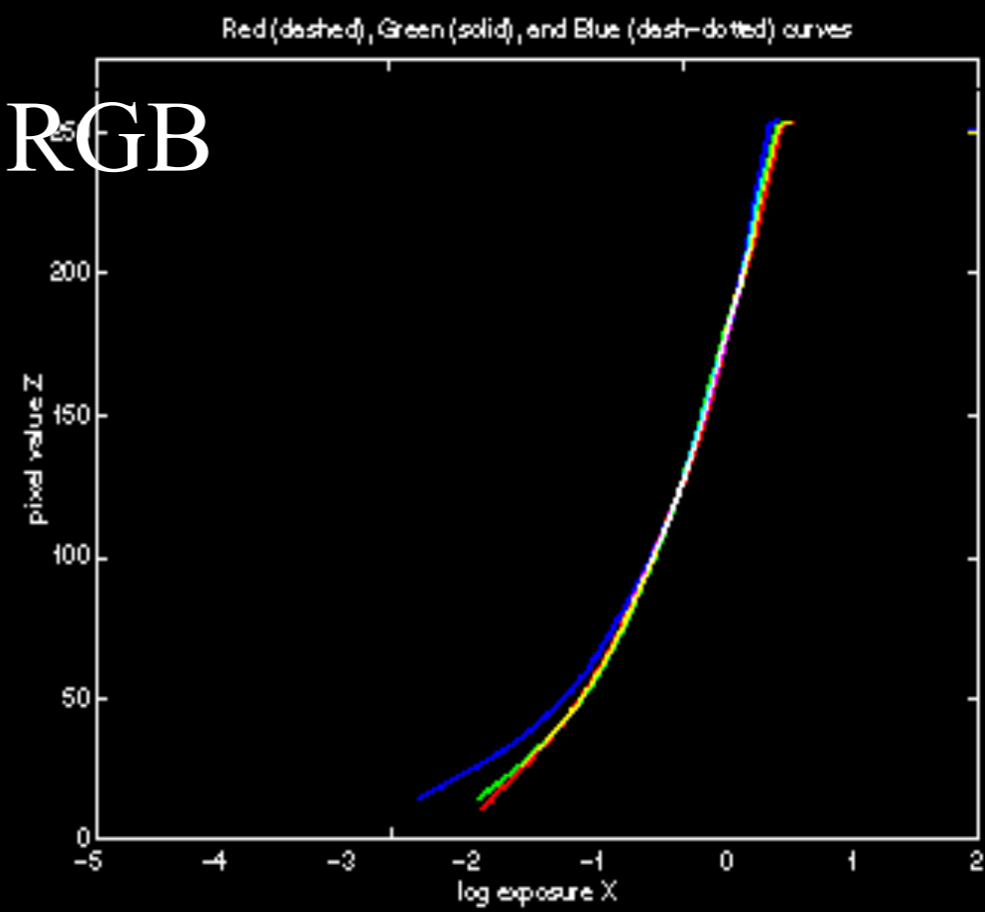

Red (dashed), Green (solid), and Blue (dash-dotted) curves

# Radiance

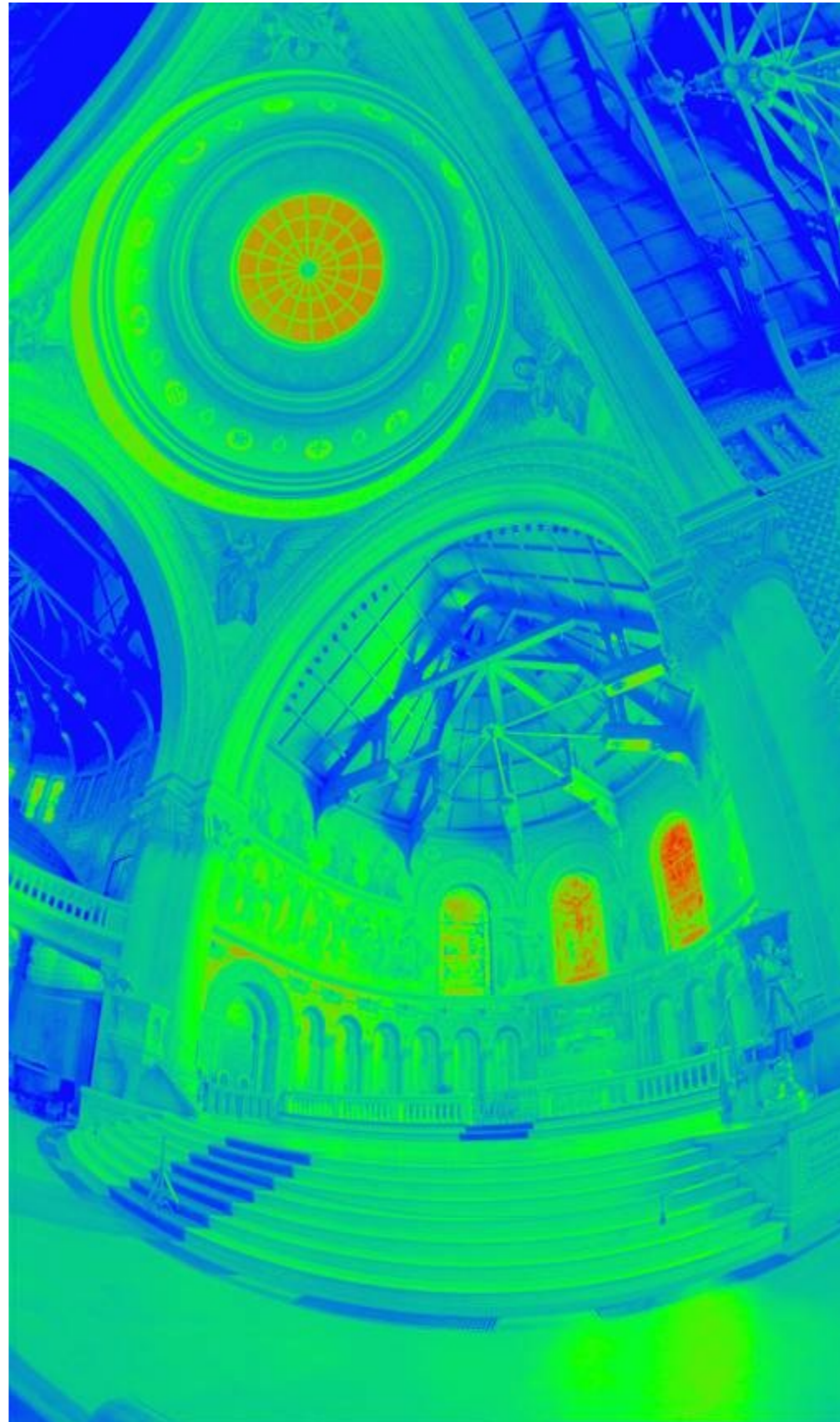

# Radiance



Image précédente  
entre 0 et 255

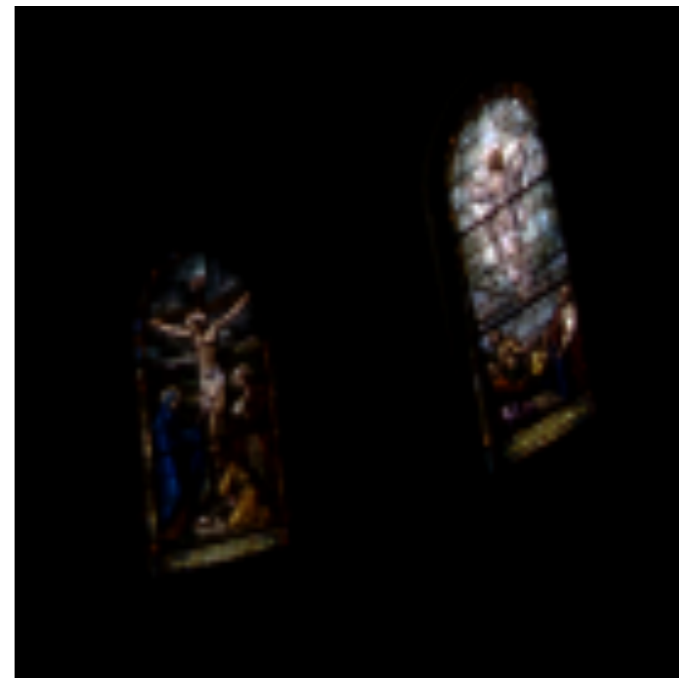

# Et maintenant?

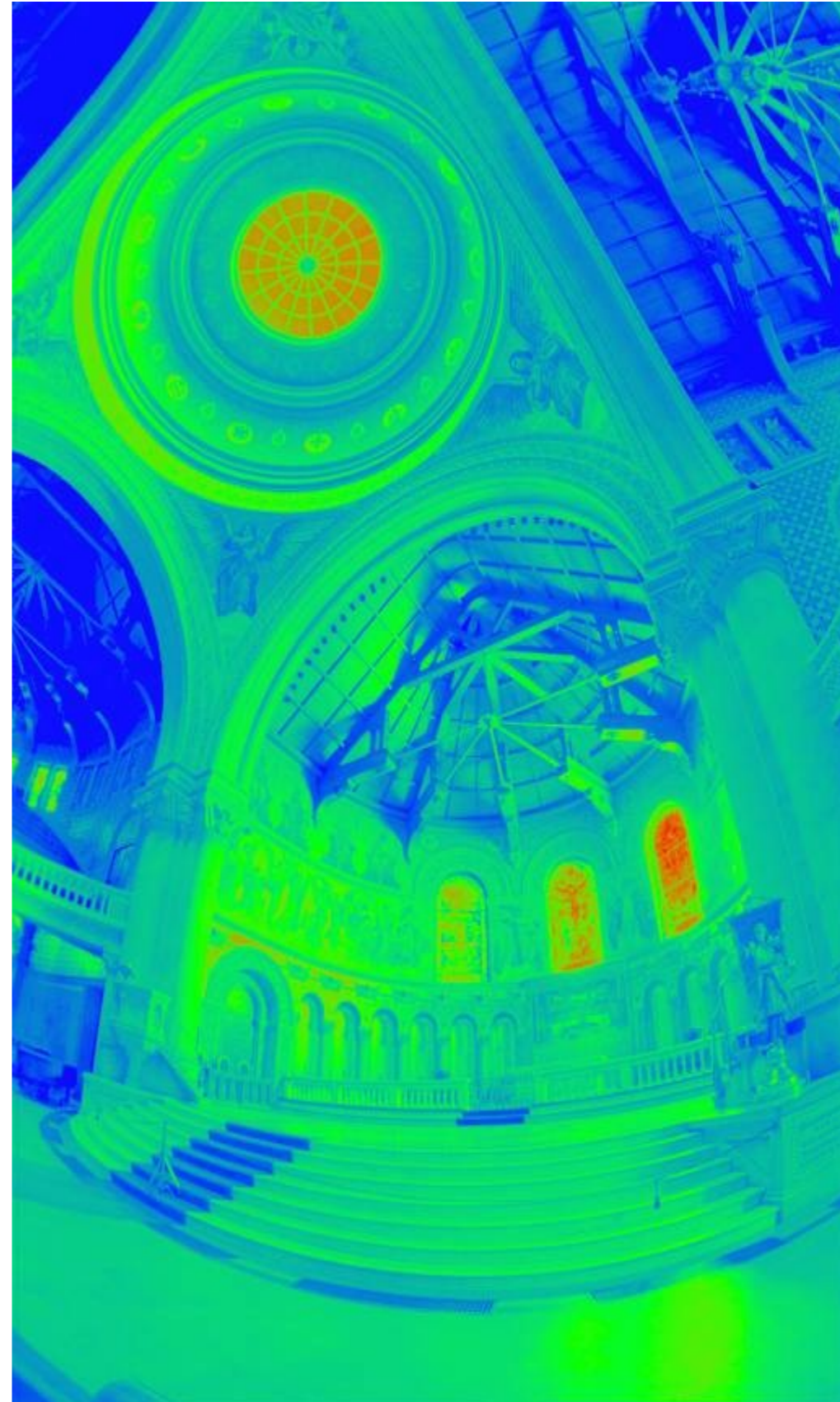



# Reproduction tonale

- Comment faire?
- Linéaire? Seuil? Suggestions?

$10^{-6}$  Haute plage dynamique  $10^6$

Monde

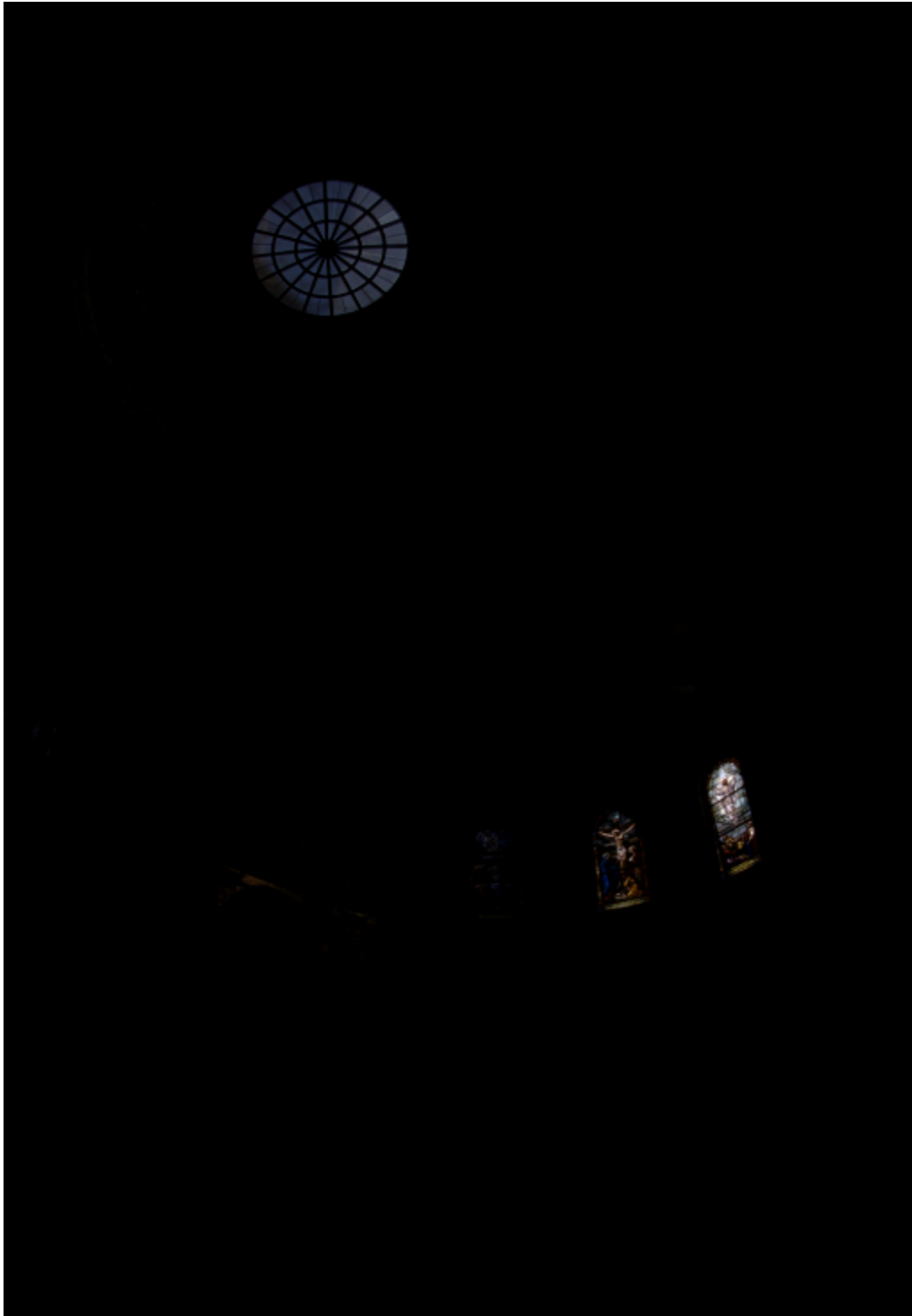

Image  
(écran,  
projecteur)



0 à 255

# Linéaire



En fonction des pixels  
les plus clairs

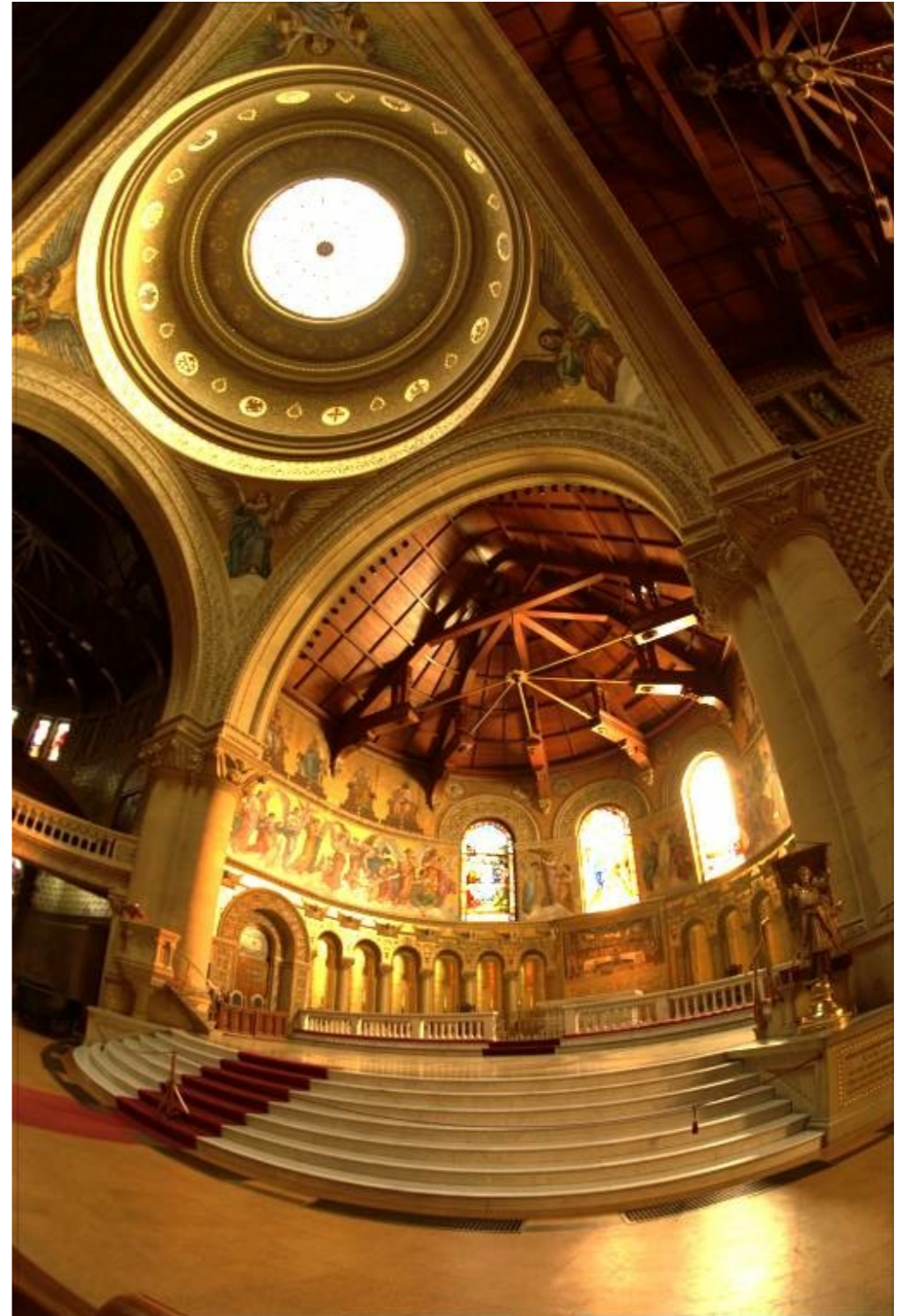

En fonction des pixels  
les plus sombres

# Opérateur global

- Déterminer une courbe qui:
  - Ramène le contenu du signal HDR dans une plage qui convient à un écran ou un projecteur
  - N'augmente pas les parties sombres
- Donc:
  - Asymptote à 255
  - Dérivée = 1 à 0

# Opérateur global (Reinhard et al.)

- Solution toute simple: utiliser une transformée non-linéaire

$$L_{display} = \frac{L_{world}}{1 + L_{world}}$$

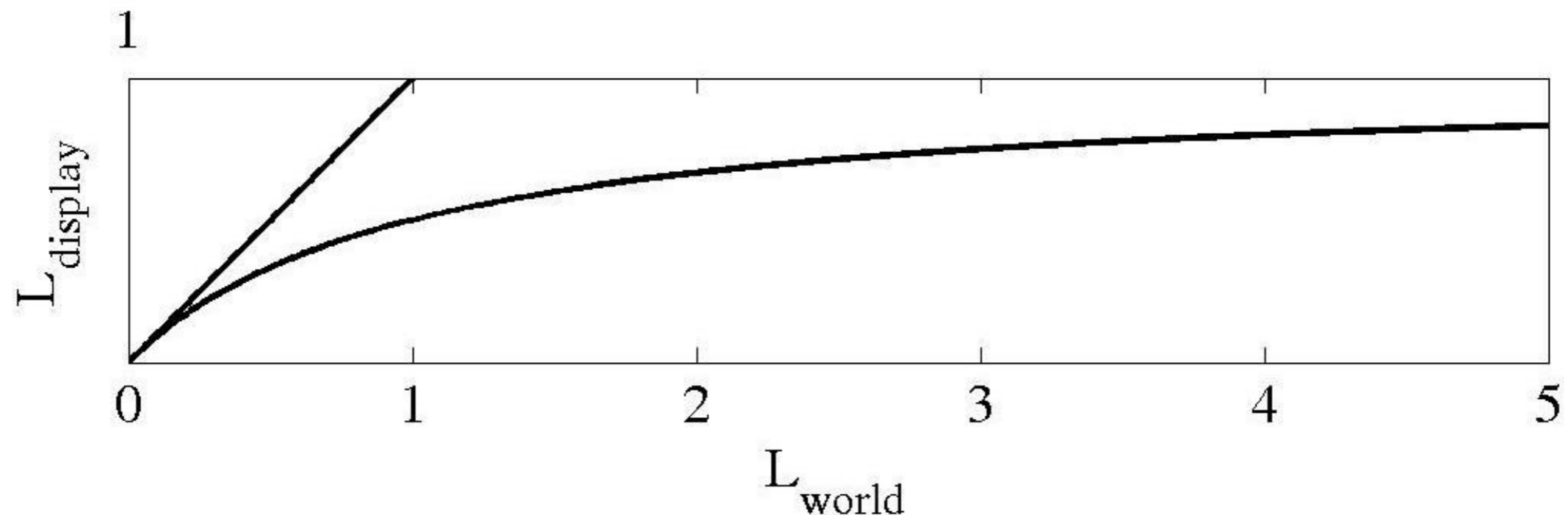

# Non-linéaire

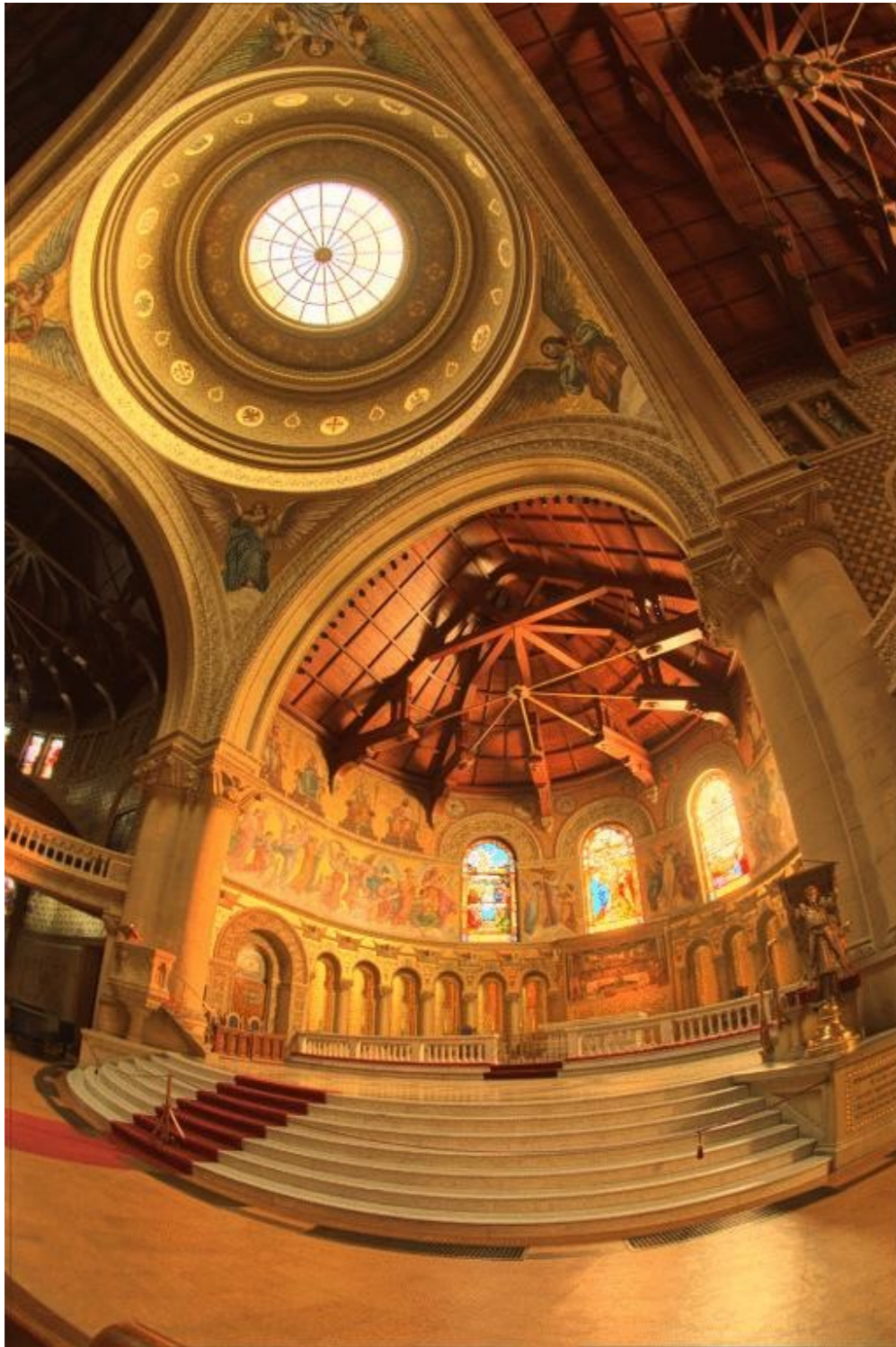

Reinhard



En fonction des pixels  
les plus sombres

# Opérateur global

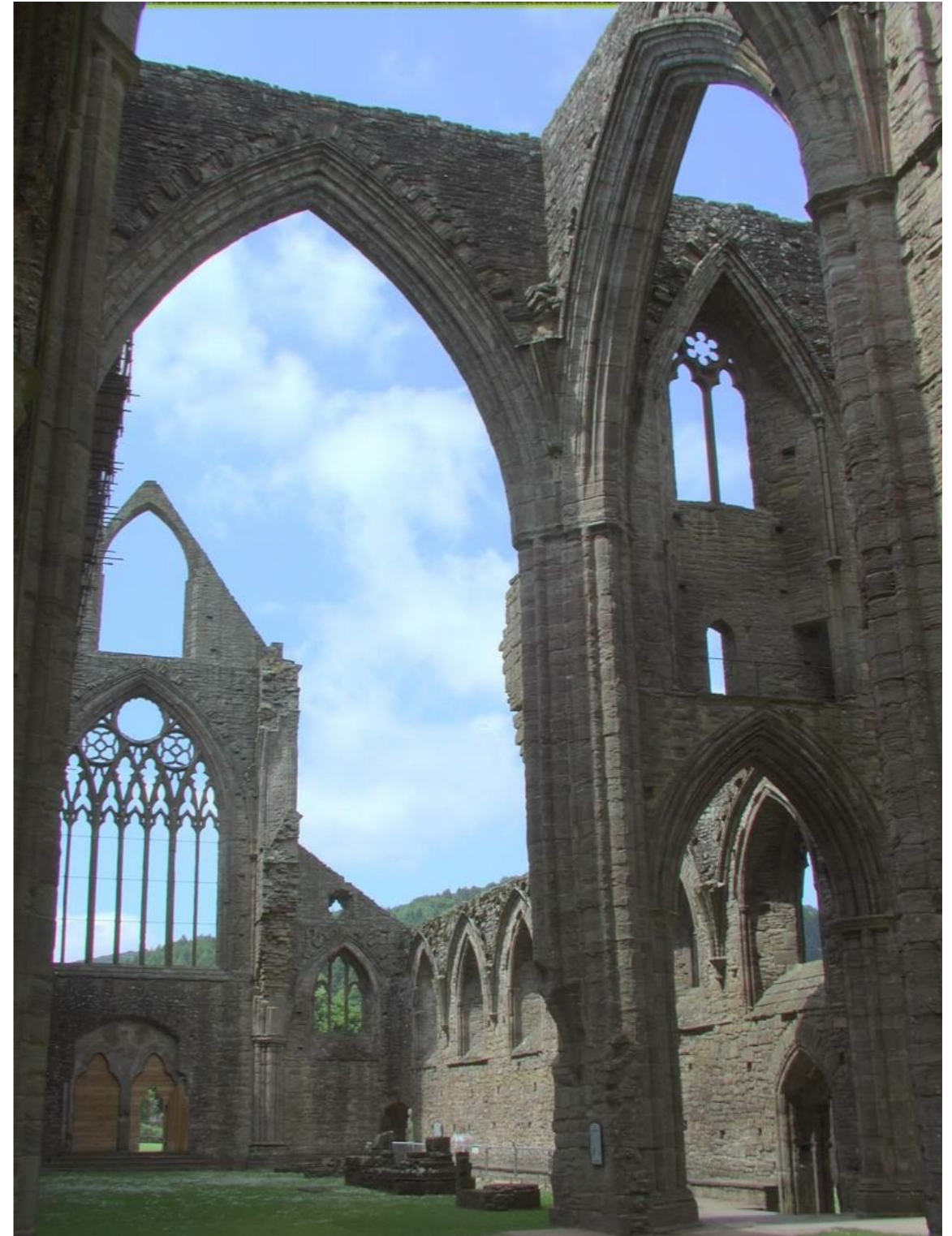

# Qu'est-ce que nos yeux voient?

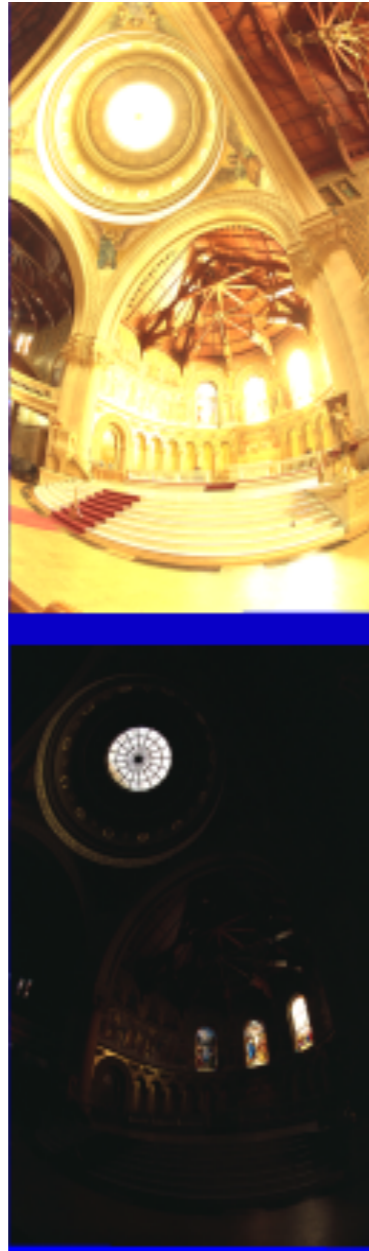

Vs.

